

A Design of the Next Generation Mobile Healthcare Application for Electronic Medical
and Pharmaceutical ERP Systems

By
Nouf Hatem Alarnous

A Thesis Submitted to
Saint Mary's University, Halifax, Nova Scotia
in Partial Fulfillment of the Requirements for
the Degree of MSc in Applied Science

April, 2016, Halifax, Nova Scotia

Copyright Nouf Hatem Alarnous, 2016

Approved: Dr. Hai Wang
Supervisor

Approved: Dr. Michael Zhang
Examiner

Approved: Dr. Pawan Lingras
Examiner

Approved: Dr. Qigang Gao
External examiner

Date: April 29, 2016

A Design of the Next Generation Mobile Healthcare Application for Electronic

Medical and Pharmaceutical ERP Systems

by Nouf Hatem Alarnous

Abstract

Abstract: This thesis presents an architecture and design of a mobile healthcare application supporting the next generation electronic medical and pharmaceutical enterprise resource planning systems. The proposed mobile application will provide services to several parties in the healthcare sector such as patients, doctors and pharmacists. The proposed application aims to decrease the transaction processing time and cost, and to allocate flexibility to pervasively access the information anywhere, anytime and as needed. A prototype of the proposed mobile healthcare application was implemented using Java with MySQL and PHP.

April 29, 2016

Table of Contents

Abstract	i
Table of Contents	ii
List of Tables	iii
List of Figures	iv
List of Abbreviations	vi
1. Introduction	1
1.1 Thesis Objectives and Contributions.....	2
1.2 Thesis Roadmap.....	5
2. Literature Review	6
2.1 Related Work.....	6
2.1.1 Mobile Healthcare Applications.....	6
2.1.2 Medical and Pharmaceutical ERP Systems.....	11
2.1.3 Other Healthcare Systems.....	13
2.1.4 Discussion.....	14
2.2 Problem Formulation	15
2.2.1 Expected Advantages and Effectiveness of Mobile Healthcare Applications.....	17
2.2.2 Possible Criticism for Mobile Healthcare Applications.....	18
3. Architecture and Design of the System	20
3.1 Users and Information Queries.....	20
3.2 Functional Specifications.....	22
3.2.1 User Requirements.....	22
3.2.2 System Requirement Specifications.....	25
4. A Prototype: Implementation and Database	38
4.1 Implementation Tools and Services	38
4.2 Database Diagram.....	41
4.2.1 Data Dictionary.....	47
4.3 Web Services Implemented for the Prototype	56
5. Case Study and Application Interface	76
5.1 Patient Case Study.....	80
5.2 Doctor Case Study.....	85
5.3 Pharmacist Case Study.....	87
5.4 Admin Case Study.....	89
6. Conclusions and Future Work	94
6.1 Conclusions	94
6.2 Future Work	95
7. Bibliography	96

List of Tables

Table 1: em_family_history Table.....	47
Table 2: em_hospitals Table	48
Table 3: em_medical_reports Table	48
Table 4: em_medical_report_allergies Table	49
Table 5: em_medical_report_diagnosis Table.....	49
Table 6: em_medical_report_health_care_providers Table	50
Table 7: em_medical_report_medication Table.....	50
Table 8: em_medical_report_vital_signs Table	51
Table 9: em_patient_details Table	52
Table 10: em_pharmacy Table.....	52
Table 11: em_pharmacy_location Table.....	52
Table 12: em_prescription Table	53

List of Figures

Figure 1: Framework for the Proposed Mobile Healthcare Application.....	3
Figure 2: SDLC	4
Figure 3: System's Context Diagram	22
Figure 4: Use Case 1 Diagram	28
Figure 5: Use Case 2 Diagram	29
Figure 6: Doctor Context Diagram	30
Figure 7: Doctor Context Diagram Level 0	31
Figure 8: Patient Context Diagram.....	32
Figure 9: Patient Context Diagram Level 0.....	33
Figure 10: Pharmacist Context Diagram	34
Figure 11: Pharmacist Context Diagram Level 0	35
Figure 12: Administrator Context Diagram.....	36
Figure 13: Administrator Context Diagram Level 0.....	37
Figure 14: Database Diagram.....	41
Figure 15: ER Users Diagram	42
Figure 16: ER Patient Diagram	43
Figure 17: ER Doctor Diagram.....	44
Figure 18: ER Pharmacist Diagram	45
Figure 19: ER Medial Report Diagram.....	46
Figure 20: Registration Page	76
Figure 21: Occupation (Doctor).....	77
Figure 22: Occupation (Pharmacist).....	77
Figure 23: Login Page	78
Figure 24: Confirmation email	78
Figure 25: forgot Password Page	79
Figure 26: Password Change Key	80
Figure 27: Hospital or Pharmacy Patient Page.....	80
Figure 28: Search for Patient Screen.....	81
Figure 29: View Medical Report Screen.....	81
Figure 30: View Laboratory Report Screen	82
Figure 31: View Radiology Report Screen	82
Figure 32: Pharmacy Screen.....	83
Figure 33: View Prescription Screen	84
Figure 34: View Prescription Details	84
Figure 35: Get my Prescription Ready Screen.....	85
Figure 36: Search for Patients Screen	86
Figure 37: Search for Patient Screen 2.....	86
Figure 38: Add Prescription Screen.....	87
Figure 39: Pharmacist Screen.....	88
Figure 40: Send email Screen.....	88

Figure 41: View Insurance Screen 89

Figure 42: Update Insurance Screen 89

Figure 43: Search for User (Admin Screen) 90

Figure 44: Search Screen (Patient) 91

Figure 45: Edit Patient Screen 91

Figure 46: Edit Reports Screen 92

Figure 47: Edit medical report screen 93

List of Abbreviations

ERP	Enterprise Resource Planning
SIN	Social Insurance Number
DOB	Date of Birth
OTP	One Time Password
SQL	Structured Query Language
URL	Uniform Resource Locator
API	Application program interface
HAMS	Healthcare Alert Management System
MAMA	The Mobile Automated Medical Alert
SDLC	System Developing Life Cycle
GPRS	General Packet Radio Service
PHP	Hypertext Preprocessor
IDE	Integrated Development Environment
ONC	Office of the National Coordinator for Health Information Technology
POTS	Plain Old Telephone System
IC	Inventory Control Packages
MRP	Material Requirements Planning Systems
MRP II	Manufacturing Resource Planning Systems
ER	Entity Relationship Diagram

Chapter 1

Introduction

Due to the development of mobile technologies, traditional communication technologies have significantly extended to mobile devices. Currently, doctors and nurses are often not assigned permanent workspaces; therefore, healthcare environments are mobile by nature. Inconsistent and unusual events are generated in daily hospital routines, such as laboratory and examination results, operations rescheduling, and drug events (Kafeza et al., 2004). Additionally, many medical errors occur due to the lack of information provided at the time and location as needed. The lack of data can often cause inaccurate diagnosis and medical drug communication issues. Several studies have exhibited that ineffective communication between the patients and the healthcare team members and the lack of data provided at the right time can be the causes of medical errors in healthcare (Doukas, Pliakas, & Maglogiannis, 2010). For instance, in the United States of America the death rate from heart failure is above 42%. Many of these fatalities occur because of the delays in informing and initiating medical involvement (Chakravorty, 2006). Chatterjee et al. state that the focus of mobile healthcare has gradually taken place in hospitals in the last several years. In addition, more doctors are considering using some types of smart devices to support their work because of the limitations of time and space (cited in Wu, Li & Fu, 2011). By utilizing mobile devices, the needed medical information can be made available at any time and at any place. Certainly wireless technologies cannot

eliminate all medical errors; however, some of the informational errors can be reduced by such access to medical information. Mobile healthcare has huge potential to improve efficiency, improve healthcare quality, empower doctors to monitor their patient's health, empower patients to manage their health more comfortably out of the hospital, allow home care providers to provide better healthcare quality to seniors, and reduce the cost of care by allowing patients to make fewer visits to their doctor (Avancha, Baxi & Kotz, 2012).

1.1 Thesis Objectives and Contributions

In this thesis, we present an architecture and design of a mobile healthcare application for the next generation electronic medical and pharmaceutical enterprise resource planning (ERP) systems. Connecting various stakeholders in the healthcare sector such as patients, doctors and pharmacists. The significance of creating a mobile healthcare application is that it incorporates preventive care services for all stakeholders in the healthcare sector. Currently, similar technologies such as the Healthcare Alert Management System (HAMS) (Kafeza et al., 2004) and the Mobile Automated Medical Alert (MAMA) (Jen, 2009), provide services only for doctors, nurses and patients. In contrast, the proposed mobile healthcare application system will incorporate preventive care services for all stakeholders in the healthcare sector as well as for organizations such as hospitals and pharmacies. The advantages of the proposed mobile application are to reduce the transaction processing time, and cost, and provide flexibility in order to access data anywhere anytime, and as needed. By using the proposed mobile healthcare application, all the stakeholders will be able to access the accurate and up-to-date information with less time and effort as well as improved efficiency of the information flow the expected outcome is that the proposed

mobile application can be accessed by various different parties. As Figure 1 shows, the proposed system will provide hospitals' information and pharmacies' information, in which the stakeholders can use their mobile devices to log into the system and get the desired information. During the project, crucial factors associated with the successful implementation of the mobile healthcare system will also be examined and identified. These factors will allow other researchers to easily implement similar systems with success.

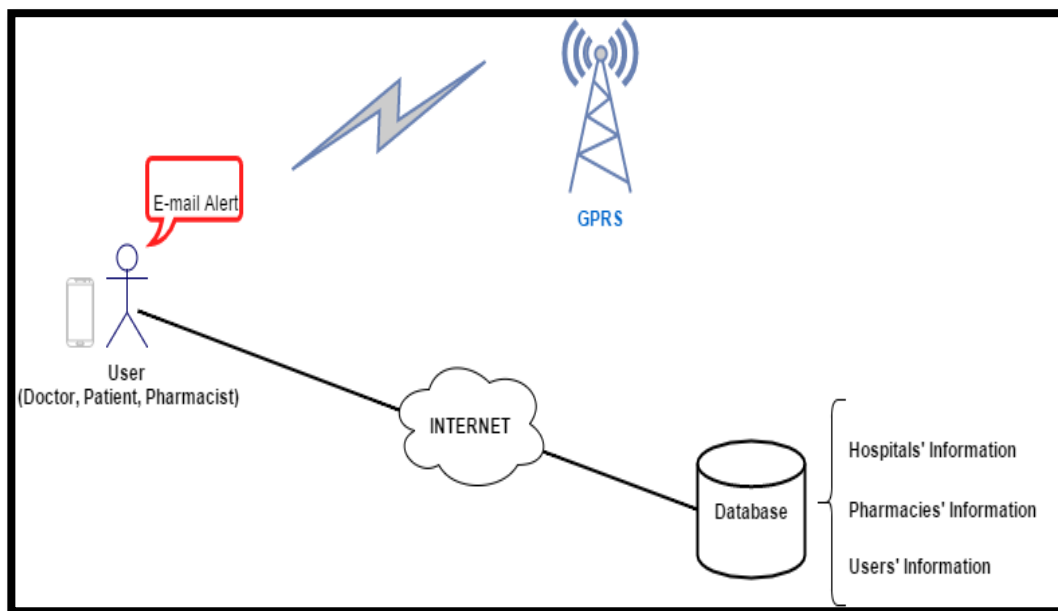

Figure 1: Framework for the Proposed Mobile Healthcare Application

In order to achieve the proposed system requirements, methods such as system developing life cycle (SDLC) will be used to analyze and design the system. As Figure 2 demonstrates, SDLC is a linear sequence of stages used to implement and develop a system from planning to analysis to design to implementation. Therefore, the first phase is to gather and create

the user requirements and the system specifications. The second phase is to design the system architecture by using use case diagrams and context diagrams. Third, simulated databases for hospitals such as IWK and QE II and pharmacies such as Shoppers Drug Mart, Lawtons Drugs, Guardian Drugs and Pharmasave Drugs will be created. Gathering real-life data from hospitals, pharmacies and insurance companies is impossible because the data are confidential. Then, the mobile application will be implemented by using PHP for web services, MySQL for database and Eclipse IDE software with Java. In addition, a trial testing of the application will be initiated on an android base smart phone. When testing is complete, the healthcare application will be ready to use by phone. Finally, additional features may be added to the system. Security and privacy properties that are affiliate with the principles in the conceptual privacy frameworks such as ONC National Framework and the Common Framework (Avancha, Baxi & Kotz, 2012; Kotz, Avancha & Baxi, 2009) will be followed in the proposed mobile application to protect and ensure the patients' health information confidentiality.

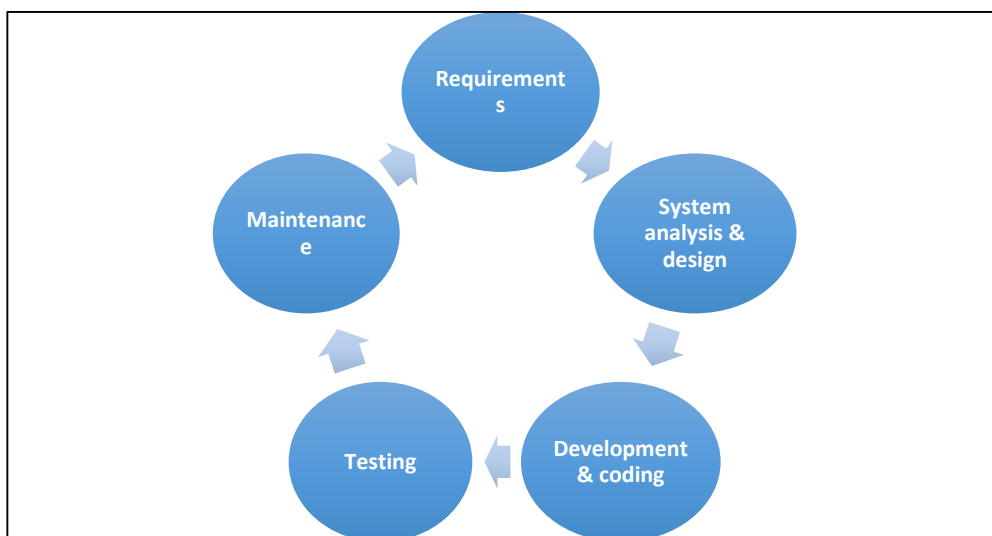

Figure 2: SDLC

Unifying and aggregating multiple database platforms is one of the challenges faced while implementing such application. Also, having the information read by the patient without interpretation may confuse the patient and increase anxiety.

1.2 Thesis roadmap

This thesis presents an architecture and design of a mobile healthcare application for the next generation electronic medical and pharmaceutical ERP systems. Chapter 2 reviews the research literature and previously proposed similar technologies. Chapter 3 presents the architecture and design of the system. Chapter 4 describes the implementation and database of the system. Chapter 5 illustrates a case study and the application interface. Chapter 6 discusses the conclusion and future work of the application.

Chapter 2

Literature Review

2.1 Related Work

This chapter will include the following related work: Mobile applications, ERP systems and healthcare systems. Also, it will include a discussion and problem formulation.

2.1.1 Mobile Healthcare Applications

A Mobile Care System with Alert Mechanism

This intelligent mobile healthcare system is capable of taking care of chronic patients by reducing the probability of death when their physiological conditions become abnormal.

The system can automatically inform the physicians or healthcare providers when the patient's health condition becomes abnormal. Then, the physician and healthcare providers can provide medical and healthcare services (Lee et al., 2007).

The Mobile Automated Medical Alert (MAMA)

The MAMA system has been implemented to improve the quality of school-based health centers (SBHCs), encourage physical activities, improve knowledge of health nutrition, promote weight control, monitor irregular cases, and most importantly, provide active healthcare services to the students and faculty (Jen, 2009).

XFitXtreme Mobile Application

XFitXtreme is a mobile application that communicate with external sensors. In this application, two different sensors were used to measure vital signs such as, heart rate and oxygen saturation. The goal of implementing XFitXtreme application is to support athletes on doing CrossFit and prevent any risk of injury by providing them with access to their vital signs (Schobel et al., 2013).

Healthcare Alert Management System (HAMS)

In today's hospitals, doctors, nurses and hospital staff members do not work at their desks; however, they are called to accomplish different tasks in several departments. Therefore, they have to be reached and updated of recent incidents and information while they are working. Tasks like operation rescheduling, medication monitoring, laboratory/examination results, emergency hospitalization, exchange of data between physicians, etc., need a large number of messages. The requests that are classified as urgent are referred to as alerts. Sometimes these alerts are not always forwarded to the right person and there are cases where parts of the data are lost or inaccurate. Consequently, the HAMS provides three crucial advantages. First, it will ensure that the alerts are delivered to the right person at anyplace and anytime. Second, an automated alert will ensure that the data is sent precisely and completely. Third, the implementation of an urgent policy that uses multiple devices at the same time to communicate the alert can raise the probability to inform the person on time. For instance, the emergency room process contains numerous tasks, some of them are clinical and the others are administrative.

Each task has a unique description, identification, and a number of roles that can execute the task. An instance of that, the task is “construct patient history” and the role that should execute this task is the physician on duty. The physician who is responsible to function this task will receive an alert message. The HAMS determines the most appropriate way to send the alert, whether through pager, cell phone or email. The task is added to the employee’s work list if s/he recognizes this task mission. However, if the physician does not recognize the task within the deadline, the HAMS will take alternative actions, such as resending the alert to the same or different employer (Kafeza et al., 2004).

Multi-purpose HealthCare Telemedicine System

The multi-purpose system has been implemented to handle diverse telemedicine needs in the fields of: emergency healthcare, patients monitoring and home telecare. The integrated telemedicine system consists of the base unit or doctor’s unit and the telemedicine or the mobile unit.

- The telemedicine unit: is located at the place where the patient’s signals and images are sent and observed. In addition, the unit is responsible for collecting and transferring biosignals and images of the patients from the incident place to the doctor's location.

The Telemedicine unit consists of four modules:

1. The biosignal acquisition module, which is responsible for collecting biosignals.
2. Digital camera, which is responsible for collecting and transmitting images.
3. Processing unit, which is basically a personal computer and a communication module (GSM, satellite or Plain Old Telephony System (POTS) modem).

- The doctors unit: is responsible for receiving the patient's collected data from the telemedicine device, transferring the data back to it and storing significant information in a local database. It is also responsible for receiving and displaying information from the telemedicine unit. The doctor unit consists of personal computer equipped with a modem, which responsible for information interchange.

The multi-purpose healthcare telemedicine system has been tested, installed, and used in two different countries Cyprus and Greece (Kyriacou, 2003).

Health Cloud Application

Health Cloud is a first model implementation of m-healthcare information management system. This application is based on cloud computing and runs Android application system. Additionally, it demonstrates three facilities by using the Amazon's S3 Cloud Storage Service to manage patient health records and their medical images. By utilizing web services and a set of APIs, cloud storage allows users to retrieve, modify, and upload medical information. Patient health record management system shows the information related to patients' status, biosignals, and medical images through application's interface (Doukas, Pliakas, & Maglogiannis, 2010).

Mobile healthcare applications were created to minimize the limitations traditional medical treatment such as, medical errors, security and privacy, small physical storage. Also, to allow users to access their health records easily and conveniently at anytime and anywhere. (Dinh et al., 2013; Kohn, Corrigan & Donaldson, 2002; Kopec et al., 2003).

The development of m-healthcare provides tremendous benefits for the users; however, the used information related to personal health is sensitive. Therefore, several solutions were proposed to protect the patient's health data. One solution is to use peer-to-peer paradigm to federate clouds that may belong to different administrators to address security, data protection and ownership (Hoang & Chen, 2010). Other solution is to provide security as a service on the cloud to protect mobile applications. For example, when mobile devices access a specific application, security verification is performed in the cloud (Nkosi & Mekuria, 2010). Therefore, security issue should not be worried about because it is ensured by the security vendor.

MyChart

My Chart is a Canadian website created by Sunnybrook Health Sciences Centre's eHealth initiative to serve Sunnybrook patients with chronic diseases such as Type1 and Type 2 diabetes or hypertension. Patients can access their health details, online appointment requests, online patient questionnaires, clinic visit notes, personal address book, personal diary, test results and health information ("Consumer e-health portal", 2010).

Sunnybrook is working with Baycrest hospital and the Central Community Care Access Centre to provide MyChart to the consumers ("Online health records", 2011).

Health information is securely moved and provided by using Telus health space and e-record system to Sunnybrook patients. Doctors can also access patients' records to see medication history and allergy information ("Consumer e-health portal", 2010).

2.1.2 Medical and Pharmaceutical ERP Systems

Due to the growth forecasts in the healthcare system and the popularity of ERP systems in the private sector, it is believed that the rate of adoption of ERP systems by healthcare organizations will continue to increase (Rocha, 2013; Poba-Nzaou et al., 2014). There are three categories of motivations in the private sector that lead an organization to adopt an ERP solution. First, to improve the performance of the present operations. Second, to integrate information and systems. Third, to prevent a competitive disadvantage from becoming dangerous. On the other hand, there are four types of motivations in the public sector that lead an organization to adopt an ERP solution: technological performance, operational performance, strategic performance and financial performance. Technological motivations apply to the IT infrastructure while operational motivations are related to the improvement of organizational processes. Strategic motivations apply to a change in the design or delivery of services, in the image of the organization, or in strategic orientation. Lastly, financial motivations are related to revenue growth, cost reduction and profitability. In the healthcare sector, there are three empirical studies of ERP systems; however, none of the studies focused on the motivations that emphasize the adoptions of ERP systems (Poba-Nzaou et al., 2014). The major vendors of ERP systems such as, SAP and Oracle, believe that healthcare and hospitals are considered to be a new and growing market. Thus, special healthcare applications have been developed to fit the ERP system with the hospital setting. Hospitals differ from other industries for several reasons. First, the hospitals' goals are distinct. For example, hospitals offer treatment for patients, as well as train and educate new nurses and doctors. Second, hospitals processes are greatly varied and complicated

than processes in other industries. Third, the hospitals 'staff is diverse and includes a large range of professionals that can be categorized by having independence, power and expertise. The mentioned above characteristics effect the implementation and use oERP systems. For example," Given the diversity of the hospital workforce, the implementation and use of an ERP system requires the cooperation of a large spectrum of professionals, ranging from medical practitioners, such as doctors, nurses and laboratory assistants, to groups that provide non-medical services, such as hospital managers and IT departments. Heeks (2006) suggested that in this context, three different rationalities may collide, namely technical, managerial and medical. Technical rationality is associated with IT professionals and IT suppliers, who share a technical worldview on which they base their system designs. Managerial rationality applies to hospital managers who operate from legal, financial and control perspectives. Medical rationality typically refers to physicians, who prefer to put medical information and patients at the centre of the system" (Boonstra & Govers, 2009). Due to the integration and standardisation, ERP systems are increasing the controllability of hospital processes. They also can be considered examples of managerial rationality that may conflict with some of the other rationalities.

Evolution of ERP systems:

Centralized computing systems was designed, implemented and developed by most organizations in the 1960s. They were mechanizing their inventory control systems by using inventory control packages (IC), which were legacy systems based on programming languages such as FORTRAN, COBOL and ALGOL. During the 1970s, material requirements planning (MRP) were established and involved in planning the products

based on the master production schedule. Manufacturing resources planning (MRP II) systems were introduced in the 1980s and focused on improving manufacturing processes by coordinating the materials with production requirements. ERP systems were firstly introduced in the 1090s with the power of integrating with other tools such as customer relationship management and supply chain management (Rashid, Hossain & Patrick, 2002; Leon, 2008).

2.1.3 Other Healthcare Systems

Mobile healthcare applications are increasing around the world. The World Health Organization found that mobile healthcare applications has been recognised in many countries; however, there is distinction in adoption level. For example, Africa had the lowest rate of mobile healthcare application adoption while North and South America and Southeast Asia had the highest adoption levels (Kay, Santos & Takane, 2011). Healthcare applications can be categorized based on the provided services such as, prevention, healthcare maintenance and checkups, short-term monitoring, long-term monitoring, personalized healthcare monitoring, incidence detection and management and emergency intervention, transportation and treatment. The general requirement needed in the healthcare systems are high level security and high level privacy. High level of security can be attained by mitigating threats to healthcare data, encryption, authentication and access control. High level of privacy can also be achieved by being aware of patient's habits, behavior, and movements, and supporting patient-selectable level of anonymity in healthcare services (Varshney, 2007). Although healthcare systems provide patients with a new quality of medical services, the complexity of healthcare systems raises essential

questions of behavior, communication and technology acceptance. For instance, future users of healthcare systems will be characterized by diversity. Therefore, relying on highly technology-experienced users is not sufficient (Ziefle & Röcker, 2010). As a result, many studies have shown that there is a crucial requisite to understand in which way emotional, physical and cognitive abilities, caused by individual learning histories and health states, may impact the usage and acceptance of healthcare technologies (Holzinger et al., 2008; Holzinger et al., 2007; Melenhorst et al., 2007). Managing chronic diseases through remote monitoring is one of the greatest healthcare challenge around the world. Remote monitoring applications enable patients to register their own health measures and send them electronically to the doctor. This keeps the patients out of doctor's offices for routine checkup and helps to decrease health care costs. Examples of remote monitoring in regard to chronic diseases is found in China, Tijuana, India and Sri Lanka. The ability to access medical care in rural areas is also a challenge in many countries around the world; however, many countries such as Japan, China and India provided the citizens in rural areas the accessibility to their electronic health records and health treatment data bases (West, 2012).

2.1.4 Discussion

Although many applications were experimented successfully in several countries around the world, such as England, Greece, Cyprus, Sweden and Netherlands (Katz & Rice, 2009; Wu, Wang & Lin, 2007), some mobile healthcare applications were not implemented successfully because of technical factors and non-technical factors (Wu, Wang & Lin, 2007). In order to have successful and useful applications, several factors should be considered. First, the mobile application designers should pay more attention to user

requirements analysis to determine the clients' expectations. For example, the functional requirements of users should be examined and then, the system will be able to provide useful data that can help in the decision making of medical providers. (Wu, Wang &Lin, 2007; Wu, Li, & Fu, 2011). Second, effective strategies should be developed in order to allow hospitals to create new opportunities and values for its customers, to increase the effectiveness of health care employees and to increase the competition between the staff (Wu, Wang &Lin, 2007). Third, wireless patient monitoring solutions should be established for the homes, nursing homes and hospitals. The solutions can be achieved by the features of wireless technologies, such as having "improved coverage and scalability of wireless networks, dependable and reliable operations, implementable and reusable wireless technologies, and expandable and modifiable wireless technologies" (Wu, Li, & Fu, 2011). In addition, the hospitals should provide training programs to increase the skill levels of the employees and encourage the staff confidence in trying new technologies. As a result, the hospital will be able to plan and design certain interactive programs for employees based on their formal and informal communication needs in their work (Wu, Li, & Fu, 2011). Also, various studies indicates that mobile device size, mobile interface, ease of use, access procedures, and training staff are the most important factors for new successful application usage (Wu, Wang &Lin, 2007).

2.2 Problem Formulation

Due to the development of mobile technologies, traditional communication technologies

have significantly extended to mobile devices. Doctors and nurses are not assigned permanent workspaces; therefore, healthcare environments are mobile by nature. Inconsistent and unusual events are generated in daily hospital routines, such as laboratory and examination results, operations rescheduling, and drug events (Kafeza et al., 2004). Additionally, many medical errors occur due to the lack of information provided at the time and location it is needed. The lack of data can often cause inaccurate diagnosis and medical drug communication issues. Several studies have exhibited that ineffective communication between the patients and the healthcare team members and the lack of data provided at the right time can be the causes of medical errors in healthcare (Doukas, Pliakas, & Maglogiannis, 2010). For instance, in the United States of America the death rate from heart failure is above 42%. Many of these fatalities occur because of the delays in informing and initiating medical involvement (Chakravorty, 2006). Chatterjee et al. state that the focus of mobile healthcare has gradually taken place in hospitals in the last several years. In addition, more doctors are considering using some types of smart devices to support their work because of the limitations of time and space (cited in Wu, Li & Fu, 2011). By utilizing mobile devices, the needed medical information can be made available at any time and at any place. Certainly wireless technologies cannot eliminate all medical errors; however, some of the informational errors can be reduced by such access to medical information. Mobile healthcare has huge potential to improve efficiency, improve healthcare quality, enable doctors to monitor their patient's health, enable patients to manage their health more comfortably out of the hospital, allow home care providers to provide better healthcare quality to seniors, and reduce the cost of care by allowing patients to make fewer visits to their doctor (Avanchara, Baxi & Kotz, 2012). Electronic Medical and

Pharmaceutical Application (EMPA) supports the next generation healthcare ERP system involving various stakeholders in the healthcare sector such as patients, doctors and pharmacists. The advantages of the previously mentioned mobile application are reducing the transaction processing time, effort and cost, and providing flexibility in order to access the needed data anywhere and anytime. By implementing the proposed application, healthcare systems will be more developed, the needed data will be exchanged between hospitals and pharmacies, all the stakeholders will be able to access the accurate and up-to-date information in less time and with low effort and money and the efficiency of the information flow in the healthcare next generation ERP systems will be improved.

2.2.1 Expected Advantages and Effectiveness of Mobile Healthcare Applications

A new study suggests that patients who read their e-health records are more likely to understand their medical issues better and to take their medications as prescribed (Zafar & Hurko, 2012). It is believed that e-health applications also make patients feel more in control and less confused, increase devotion to medications (Zafar & Hurko, 2012), improve relationships between doctors and patients, help patients to ask more informed questions (“Online health records,” 2011) and ease anxiety and confusion without extra work for health providers (Reuters, 2015). Additionally, dr. Jonathan Pell, an assistant professor at the University of Colorado in Denver, states “The hope is that increased transparency achieved by sharing electronic medical records with patients while they're in the hospital would make them more engaged in their care, more satisfied, and more likely to ask questions and catch errors” (Reuters, 2015). Also, as noted in *Advance for Nurses* article, “Having such data as diagnoses, prescriptions, and appointment schedule

bundled at one's fingertips for the patient and provider's perusal continues to prove increasingly invaluable, particularly for those patients living with chronic health conditions such as diabetes, cancer or HIV/AIDS" (Coyle, 2012). Reducing unnecessary procedures, saving nursing time and reducing emergency room visits and hospital stays are advantages using EHR and an electronic patient education component (Lindsay & Gitelman, 2012). Several studies showed that periodic electronic reminders that carry out healthy behaviors, such as diet changes and physical activities, showed a significant impact. These communications were most effective when they were frequent and personal contact with healthcare staff (Fry & Neff, 2009); therefore, frequent and included contact improves effectiveness of electronic applications (Lindsay & Gitelman, 2012). In a study of Diabetes Coach, a web-based eHealth application, email contacts between patients and nurses was the most engaging part of the program. It made the patients feel that they were motivated to play an active role in their health management and closely monitored by the nurses (Niiland et al., 2011); for that reason, the previously mentioned study shows that direct electronic contact with nurses or doctors may improve patient cooperation in self-care treatments.

2.2.2 Possible Criticism for Mobile Healthcare Applications

Some experts think that too much information can cause panic to the patient. Also, Alexander Krist, a professor at Virginia Commonwealth University in Richmond, believes that having the information read by the patient without interpretation may confuse the patient and increase anxiety ("Online health records", 2011). It is also thought that patients with less education may need more work to explain health issues to them; however,

educated patients may have an easier time understanding their health records (Reuters, 2015).

Chapter 3

Architecture and Design of the Proposed Mobile Healthcare Application

Users' data will be entered by the administrators of the system with the hospitals' and pharmacies' permission. In order to ensure data security and privacy, access control mechanisms such as password protection will be used. Also, security and privacy properties that are affiliate with the principles in the conceptual privacy frameworks such as ONC National Framework and the Common Framework will be followed in the proposed mobile application to protect and insure the patients' health information confidentiality.

3.1 Users and Information Queries:

a) Doctor:

- Can search for a particular patient.
- Can view the patient's medical reports.
- Can view the patient's radiology reports.
- Can view the patient's laboratory reports.
- Can write the prescription and add it to the patient's file.

b) Patient:

- Can view his/her medical reports.
- Can view his/her radiology reports.

- Can view his/her laboratory reports.
- Can view his/her pharmacy information.
- Can ask for the prescription to get ready.

c) Pharmacist:

- Can search for a patient.
- Can send an email to the patient after getting the prescription ready.
- Can view and update the information of the patient's insurance.

d) Administrator:

- Can search for a user.
- Can edit a user.
- Can check the retrieved update.

Figure 3 shows the system's architecture. Pharmacies, users, database and hospitals are the external entities of the system.

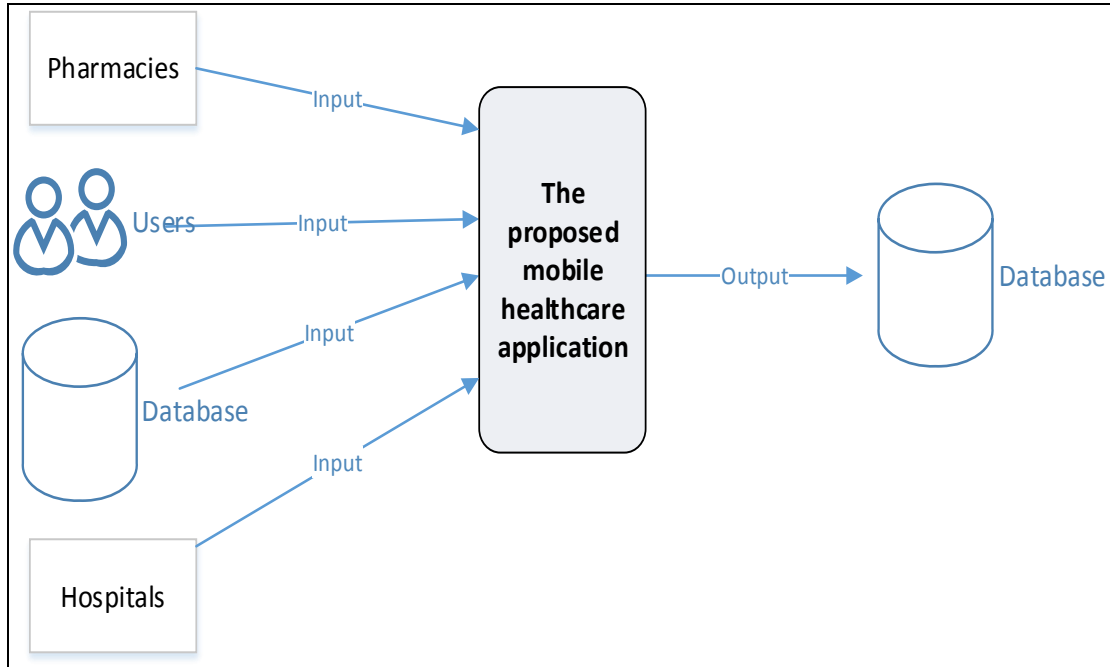

Figure 3: System's Context Diagram

3.2 Functional Specifications

3.2.1 User Requirements

1. Doctor: (as shown in figures 6 and 7)
 - The doctor shall register before login. S/He shall fill the registration form that consists of the following (First Name, Last Name, SIN, Specialization, Nationality, Gender, DOB, Address, Phone Number, Email, Position, User Name, Password) fields and receive an approval or denial via an email.
 - The doctor shall be able to login with his/her user name and password, also s/he shall be able to logout.

- The doctor shall be able to search for a patient by entering patient's first name, last name and file number.
- The doctor shall be able to view patient's reports (medical report or laboratory report or radiology report).
- The doctor shall be able to add prescription and add it to the patient's file.

2. Patient: (as shown in figures 8 and 9)

- The patient shall register before login. S/He shall fill the registration form that consist of the following (First Name, Last Name, Nationality, SIN, Gender, DOB, Address, Phone Number, email, User Name, Password) fields and receive an approval or denial via an email.
- The patient shall be able to login with his/her user name and password, also s/he shall be able to logout.
- The patient shall be able to view his/her medical reports or laboratory reports or radiology reports.
- The patient shall be able to view his/her pharmacy information.
- The patient shall be able to ask for his/her prescription to get ready.

3. Pharmacist: (as shown in figures 10 and 11)

- The pharmacist shall register before login. S/He shall fill the registration form

that consists of the following (First Name, Last Name, SIN, Gender, DOB, Address, Phone Number, email, User Name, Password) fields and receive an approval or denial via an email.

- The pharmacist shall be able to login with his/her user name and password, also s/he shall be able to logout.
- The pharmacist shall be able to search for a patient by entering the patient's first name, last name and file number.
- The pharmacist shall be able to send an email to the patient after getting the prescription ready.
- The pharmacist shall be able to view and update the information of the patient's insurance.

4. Administrator: (as shown in figures 12 and 13)

- The admin shall be able to login with his user name and password; and he shall be able to logout.
- The admin shall be able to search for a user (patient, doctor, nurse, and pharmacist) by user name, SIN and DOB to view the user's information.
- The admin shall be able to edit the user account.
- The admin shall be able to check the retrieved update.

3.2.2 System requirements specification (as shown in figures 4 and 5)

1) Registration

- The system shall enable the user to register for creating an account.
- The system shall display the registration form to fill its fields.
- The system shall check the SIN from doctor database if the registered is a doctor.
- The system shall check the SIN from patient database if the registered is a patient.
- The system shall check the SIN from pharmacist database if the registered is a pharmacist.
- The system shall respond to the registration via an email with an approval or denial.

2) Login

- The system shall enable the user to login with his/her user name and password.
- If the user name is not found or the password is wrong, the system shall display an error message asking the user to try to enter again.

3) View

- The system shall enable the doctor to view patient's reports and enable the patient to view his/her medical reports.

- The system shall display the “patient's medical reports” when s/he select the option "view medical reports”.
- The system shall display the “patient's laboratory reports” when s/he select the option "view laboratory reports”.
- The system shall display the “patient's radiology reports” when s/he select the option "view radiology reports”.
- The system shall enable the patient to view his/her reports and enable the patient to view his/her medical reports, laboratory reports, and radiology reports.
- The system shall enable the patient to view his/her pharmacy information.
- The system shall enable the pharmacist to view the patient’s prescription and insurance information.

4) Search

- The system shall enable the doctor to search for a patient by entering patient’s first name, last name and file number.
- The system shall retrieve the matching patient. If the information has not been found, the system shall display an appropriate message.

5) Edit

- The system shall display the “Edit”.
- The system shall enable the admin to edit the user account.
- The system shall display the edit result.

6) Get the prescription ready to pick up

- The system shall enable the doctor to write the prescription and add it to the patient’s file.
- The system shall enable the patient to ask for the prescription ready to pick up.
- The system shall enable the pharmacist to send an email to the patient after the prescription is ready to pick up.

7) Logout: The system shall enable the users to logout to provide more security.

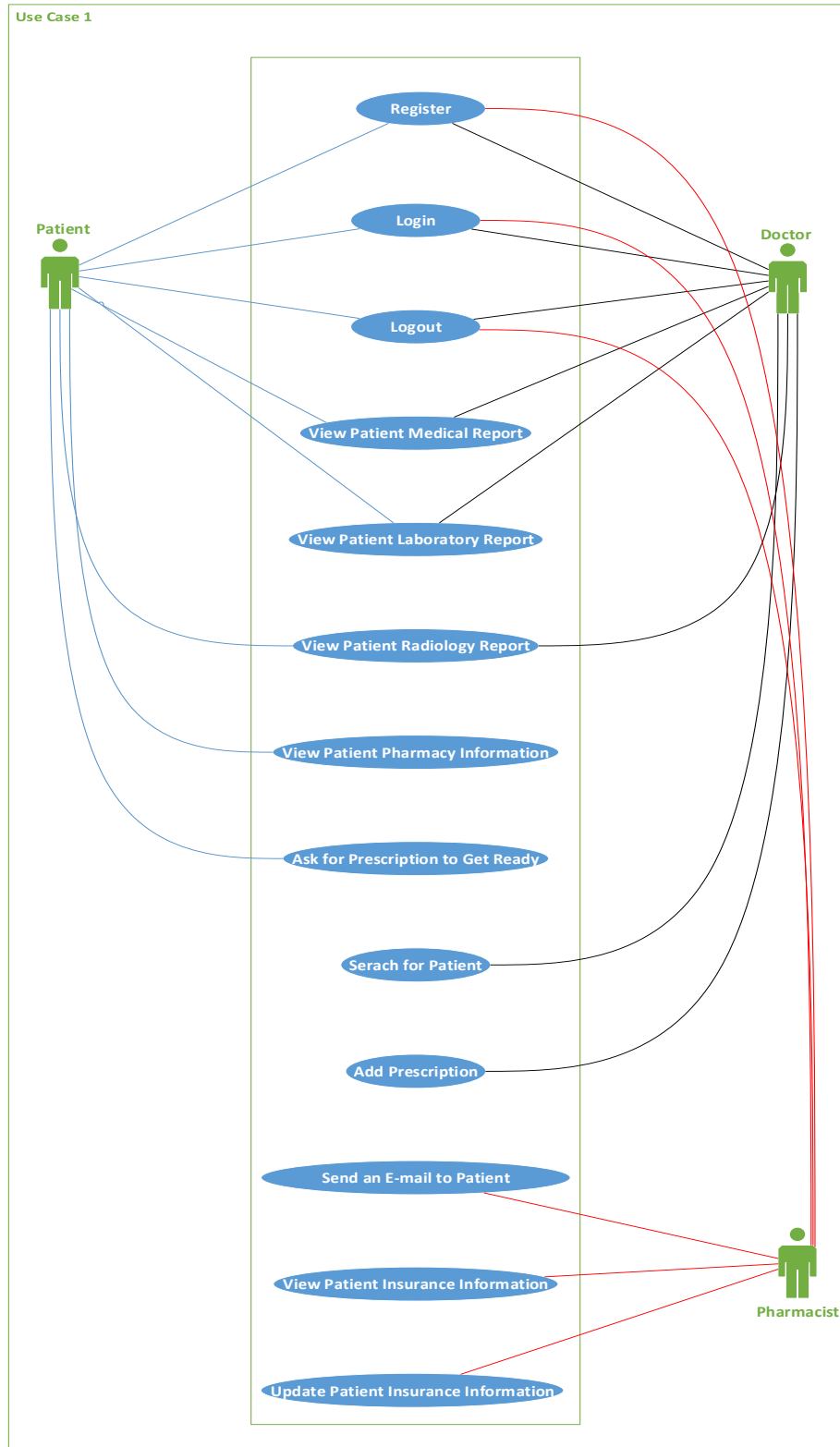

Figure 4: Use Case 1 Diagram

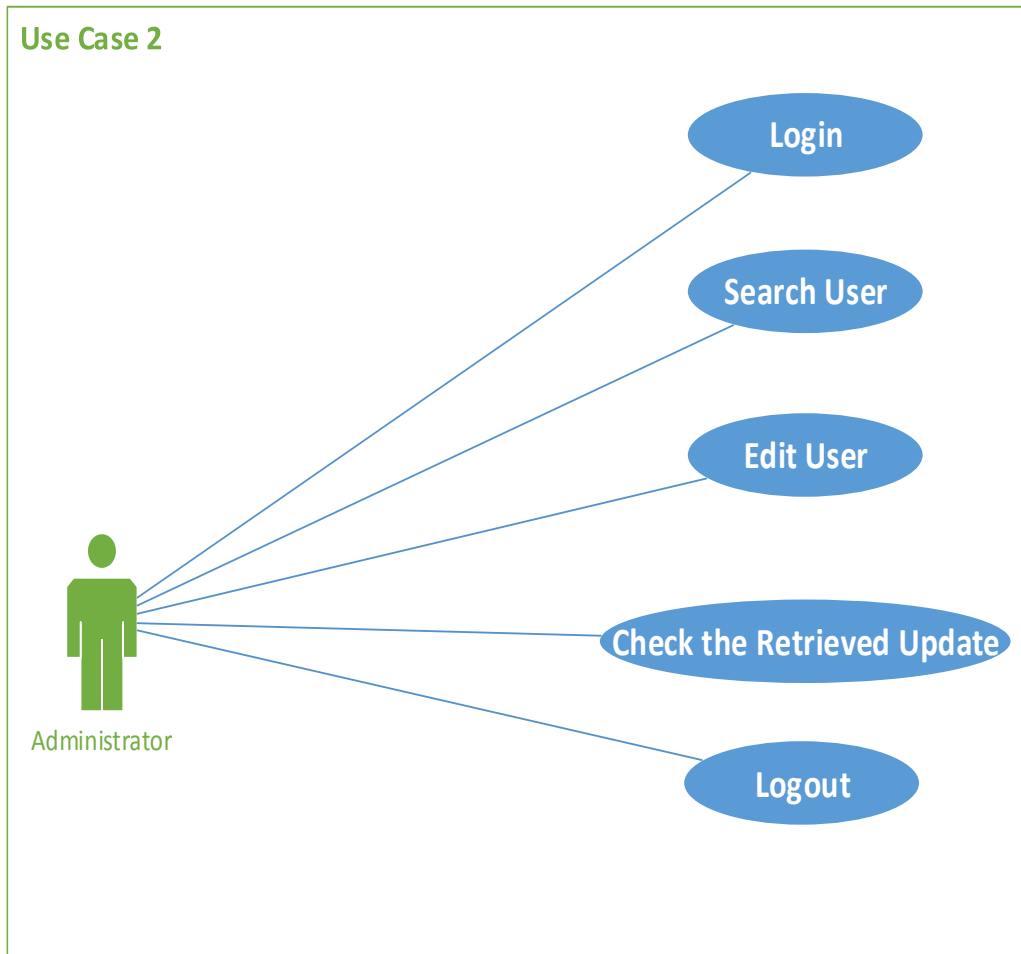

Figure 5: Use Case 2 Diagram

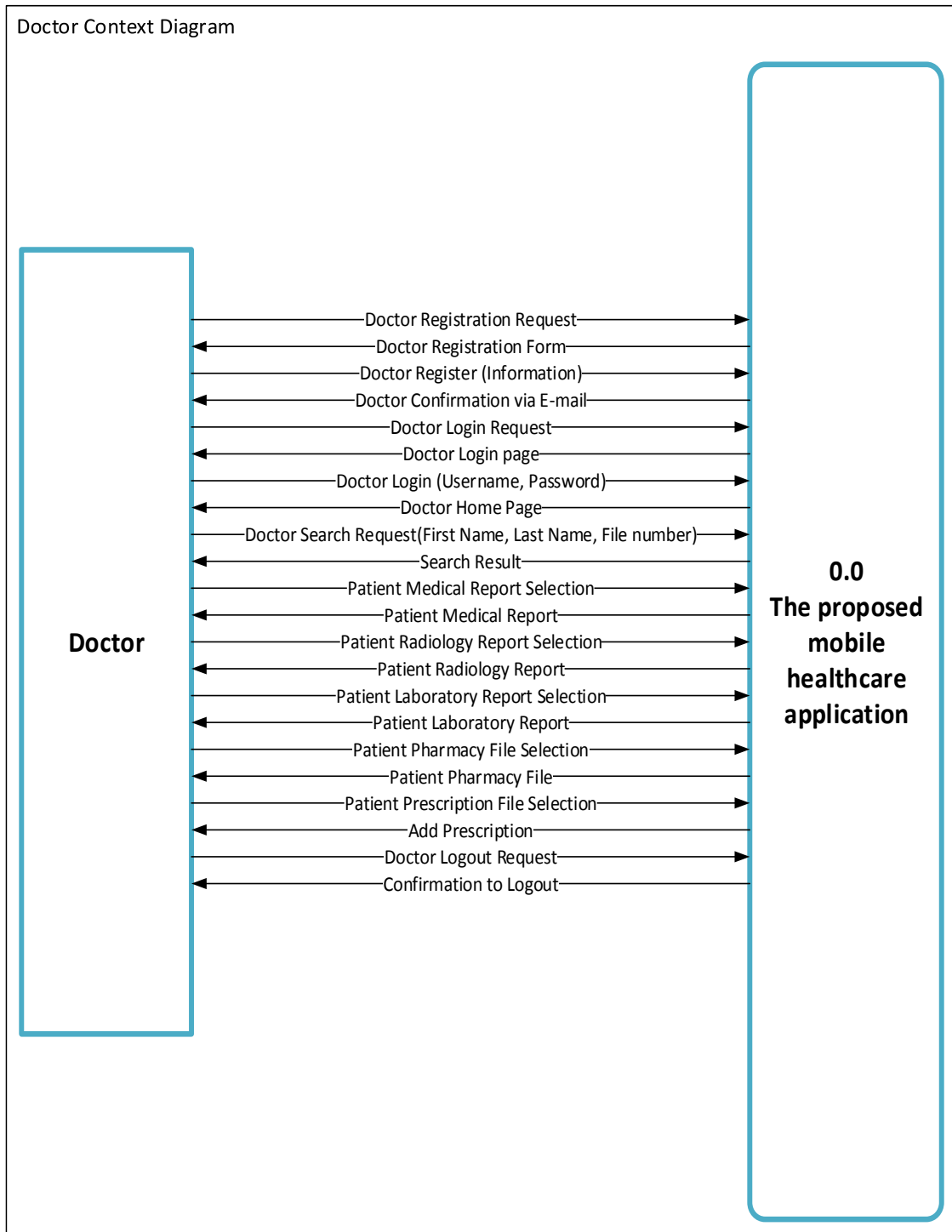

Figure 6: Doctor Context Diagram

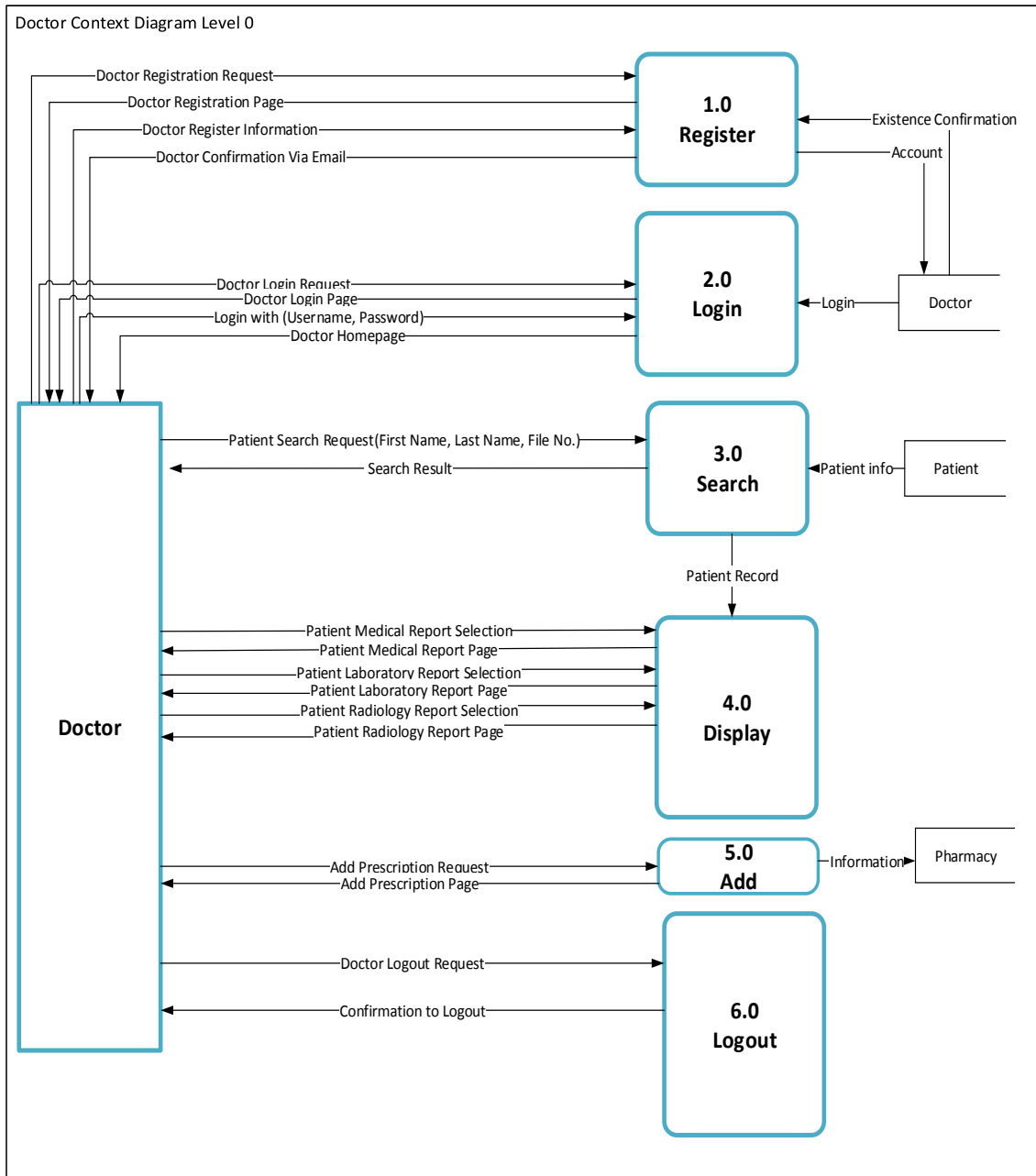

Figure 7: Doctor Context Diagram Level 0

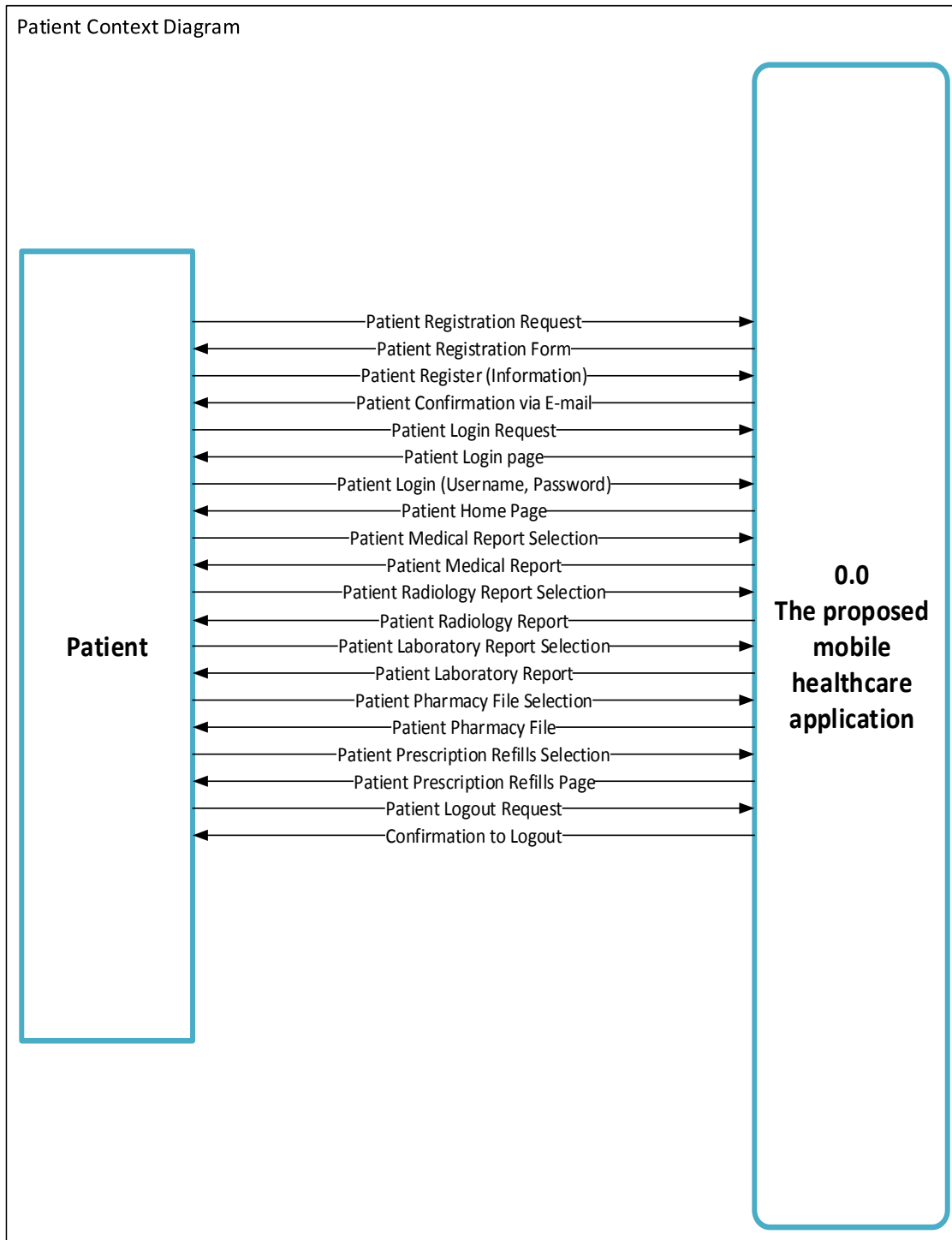

Figure 8: Patient Context Diagram

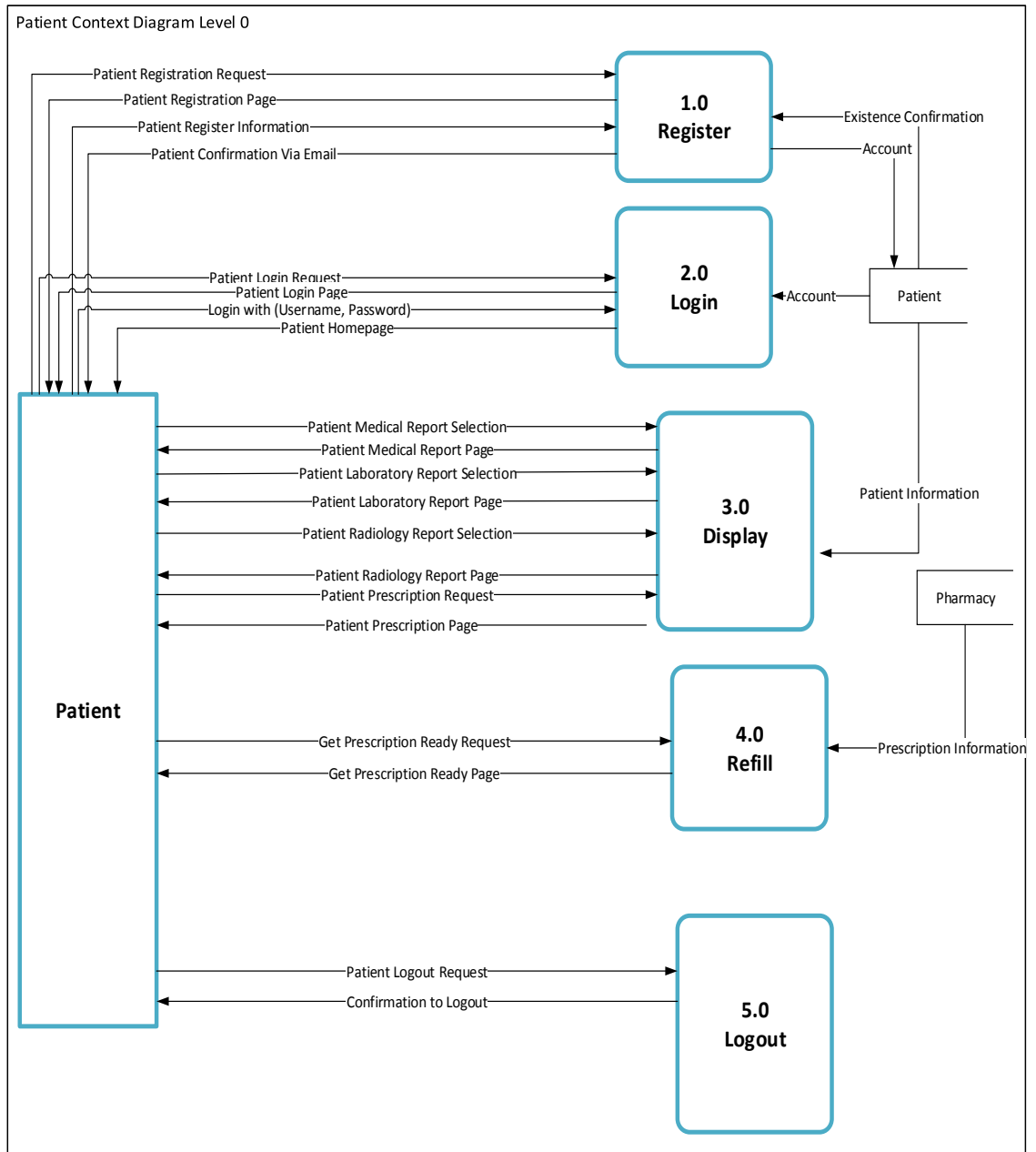

Figure 9: Patient Context Diagram Level 0

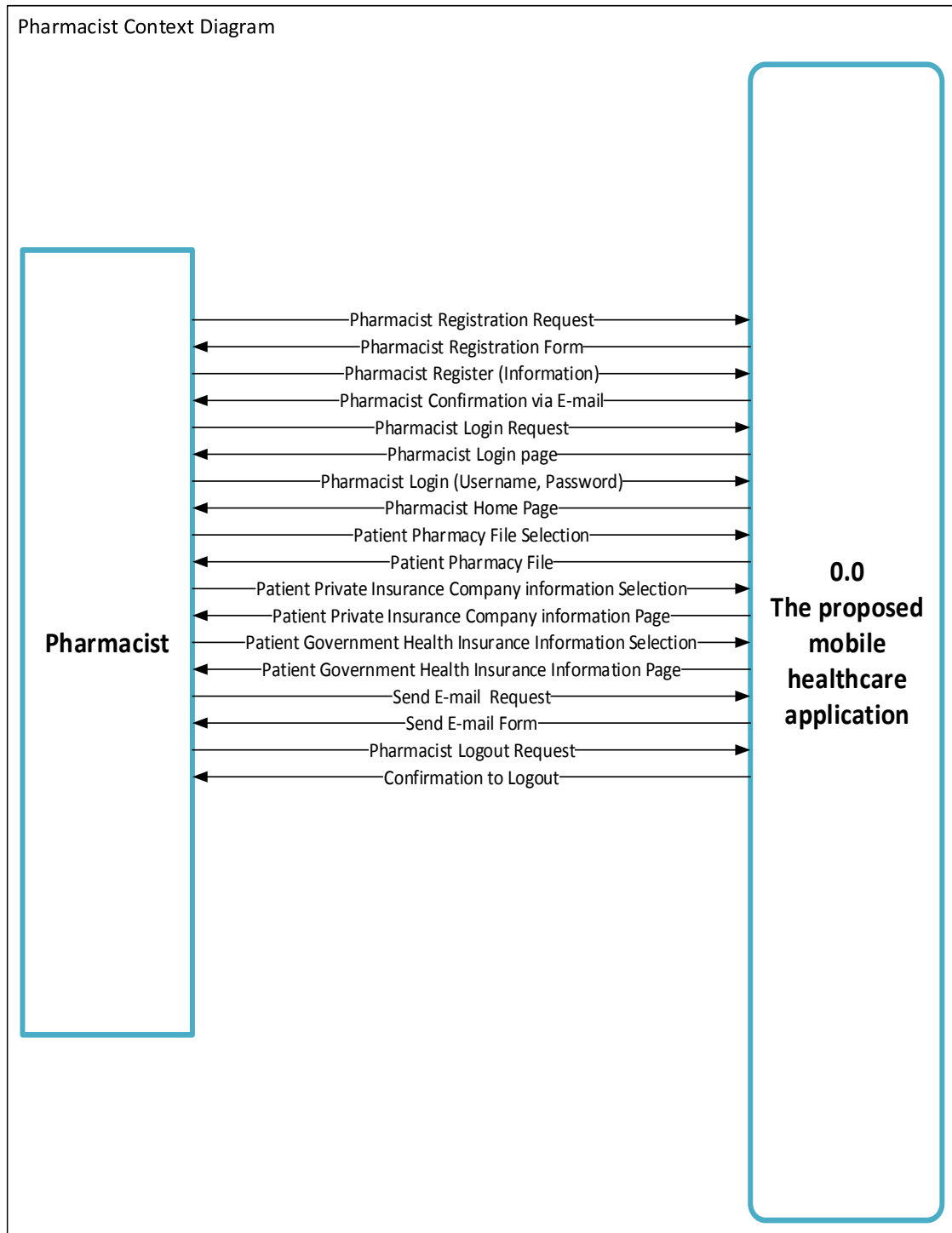

Figure 10: Pharmacist Context Diagram

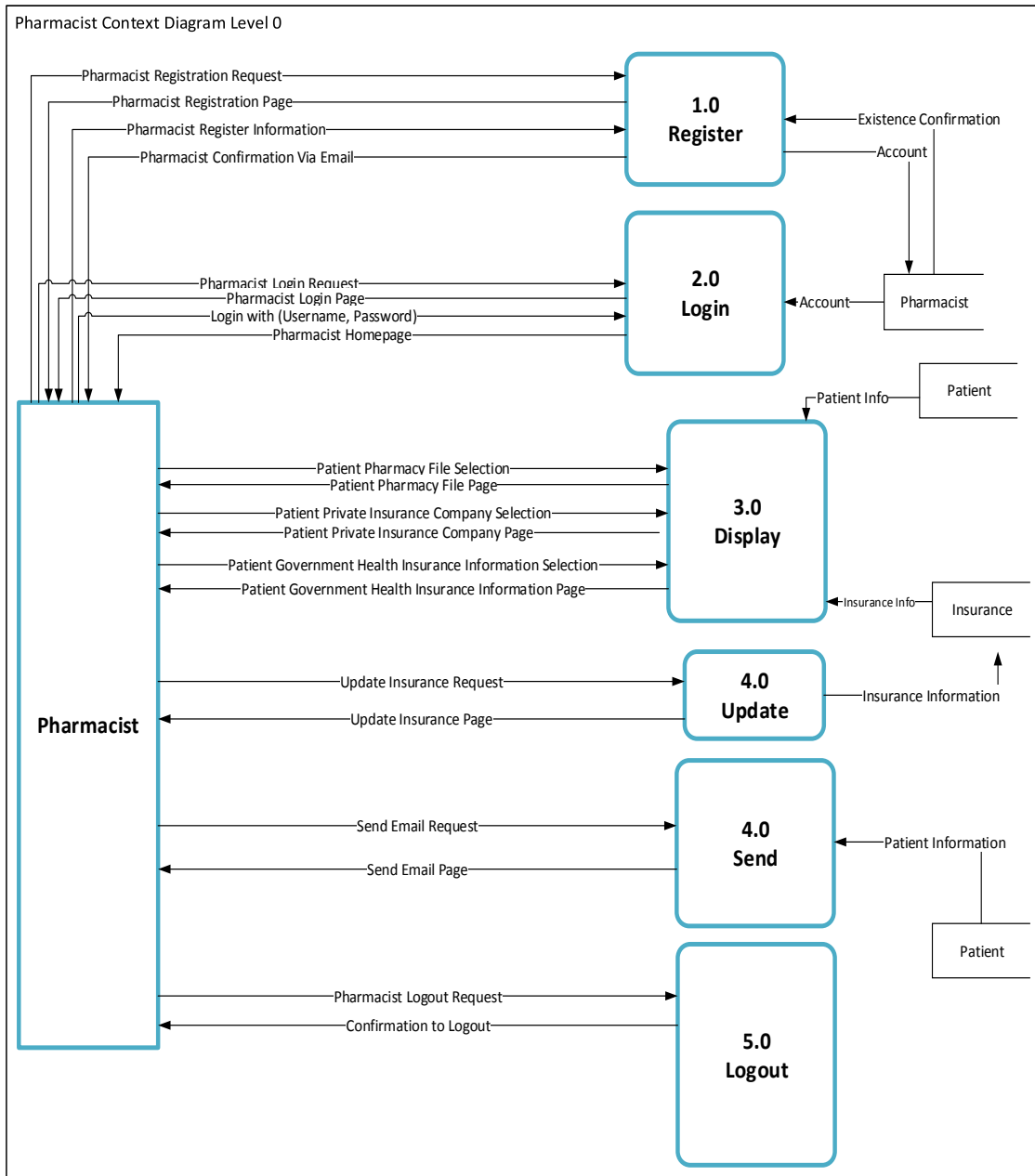

Figure 11: Pharmacist Context Diagram Level 0

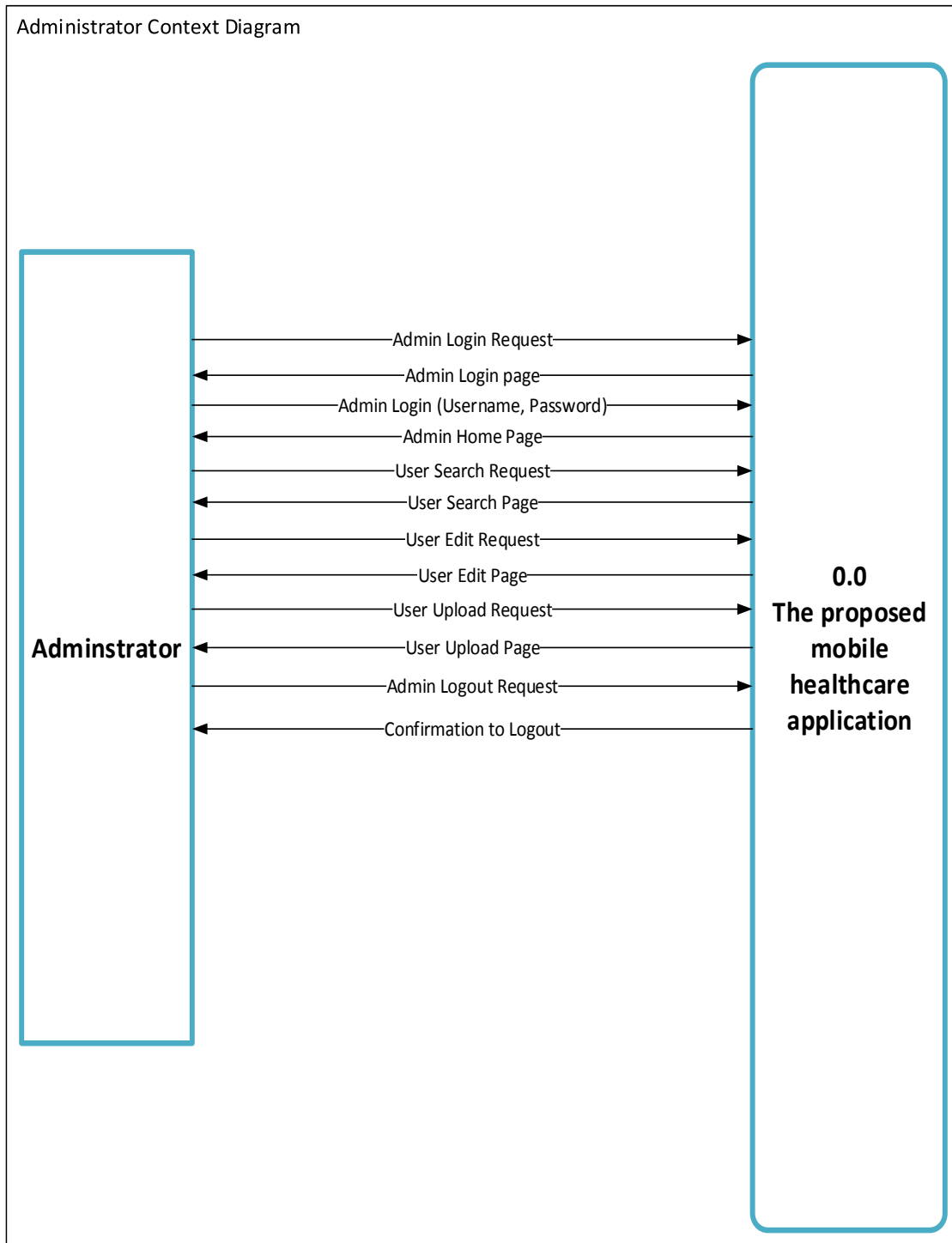

Figure 12: Administrator Context Diagram

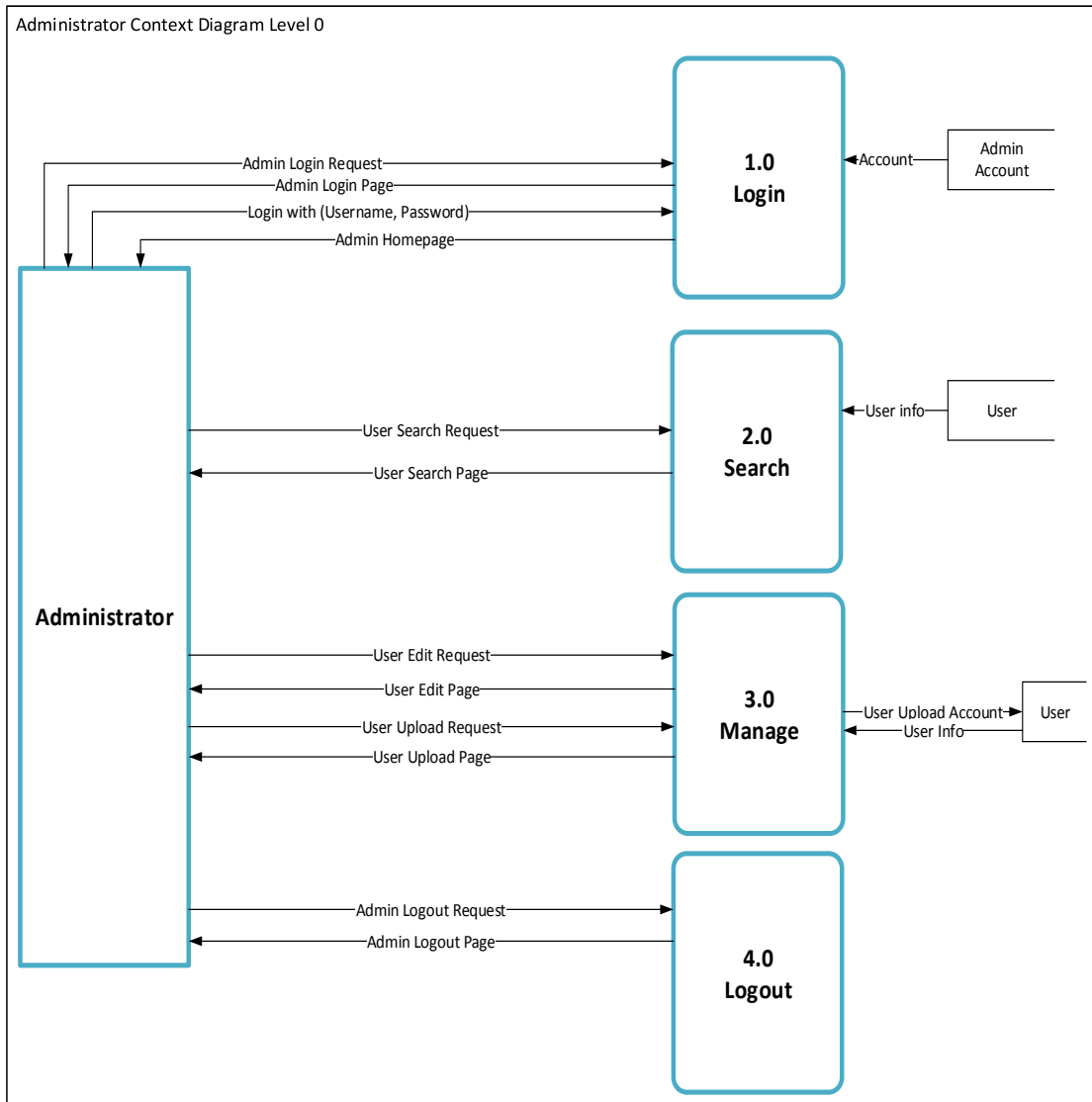

Figure 13: Administrator Context Diagram Level 0

Chapter 4

A Prototype - Implementation and Database

In this chapter, we discuss the various experimental tools that we use, the experimental services, database diagram, database dictionary and web services implementation.

4.1 Implementation Tools and Services

In this section, we describe the implementation tools that we use in our prototype. Further information on how we use them is discussed in the experimental model section.

GoDaddy Website

GoDaddy is a web hosting company and domain name registrar. It offers a comprehensive set of website building tools to its customers. We used the website to host the proposed mobile healthcare application services.

Cell phones

In this application, we used a Samsung S III GT-19300 smartphone with Android 4.2.1 platform, a 1.4GHz Quad Core Processor, and 16GB of internal memory. We used one Samsung S III GT-19300 smartphone to install and test the proposed mobile healthcare application.

MySQL

MySQL is a Relational Database Management System (RDBMS) that uses Structured Query Language (SQL). SQL is a language that is used for adding, accessing and managing content in a database. We used the tool to create a hospitals and pharmacies simulated database that contains all of the necessary data for the application's needs ("MySQL reference manual", n.d., para.1).

Eclipse IDE

Eclipse is an integrated development environment (IDE) that is used to develop applications in Java. We used Eclipse IDE because its abilities can be extended to more functions by installing the android SDK to give us the ability to create an Android app. By using this tool, we were able to create the proposed mobile healthcare application ("Eclipse documentation", n.d., para.1).

NetBeans 7.0

NetBeans is a software development platform written in Java that allows applications to be developed. We used NetBeans to develop the proposed mobile healthcare application ("NetBeans IDE 7.0.1", n.d., para.1).

PHP

PHP is a general-purpose scripting language used for web development. We used PHP in this application as a web service in the middle to connect a remote MySQL to an android

device. Thus, we used the PHP script to pass the request to the database and then return the response to the android app (“PHP”, n.d., para.1).

Location Service

We used a location service to provide the patient with the closest pharmacy based on the patient location.

Email Service

We used an email service (Gmail) to send emails in three cases:

1. When a user register into the application, a confirmation email will be sent to the user.
2. When doctor add prescription to a patient, a prescription number will be sent to the patient via email.
3. When the prescription is ready to pick up, an email will be sent to the patient from the pharmacists.

4.2 Database Design

Based on the system requirements in Chapter 3, the ER diagrams for the database design are shown in Figures 15 through 19. The resulted database tables are shown in Figure 14.

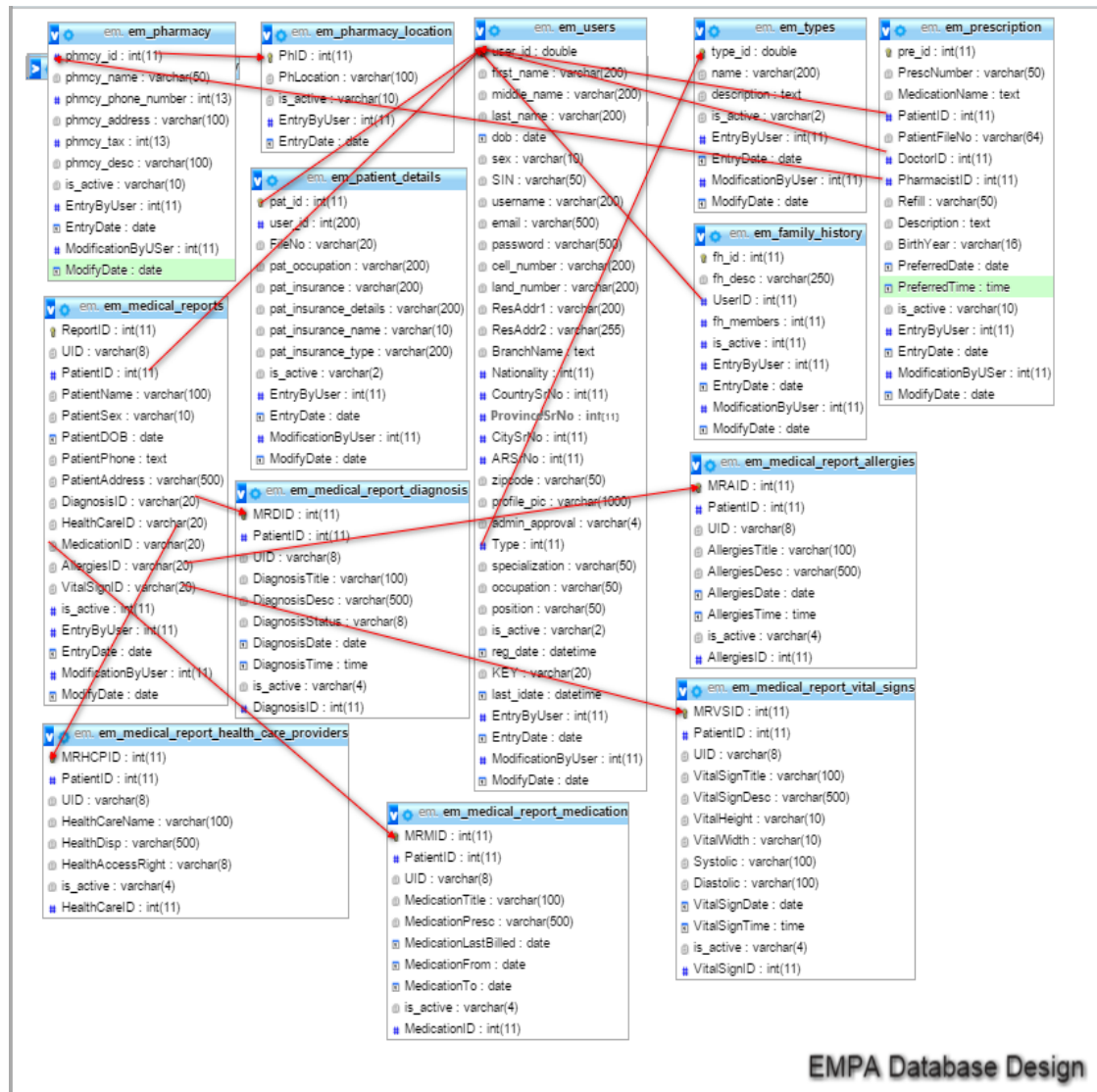

Figure 14: Database Diagram

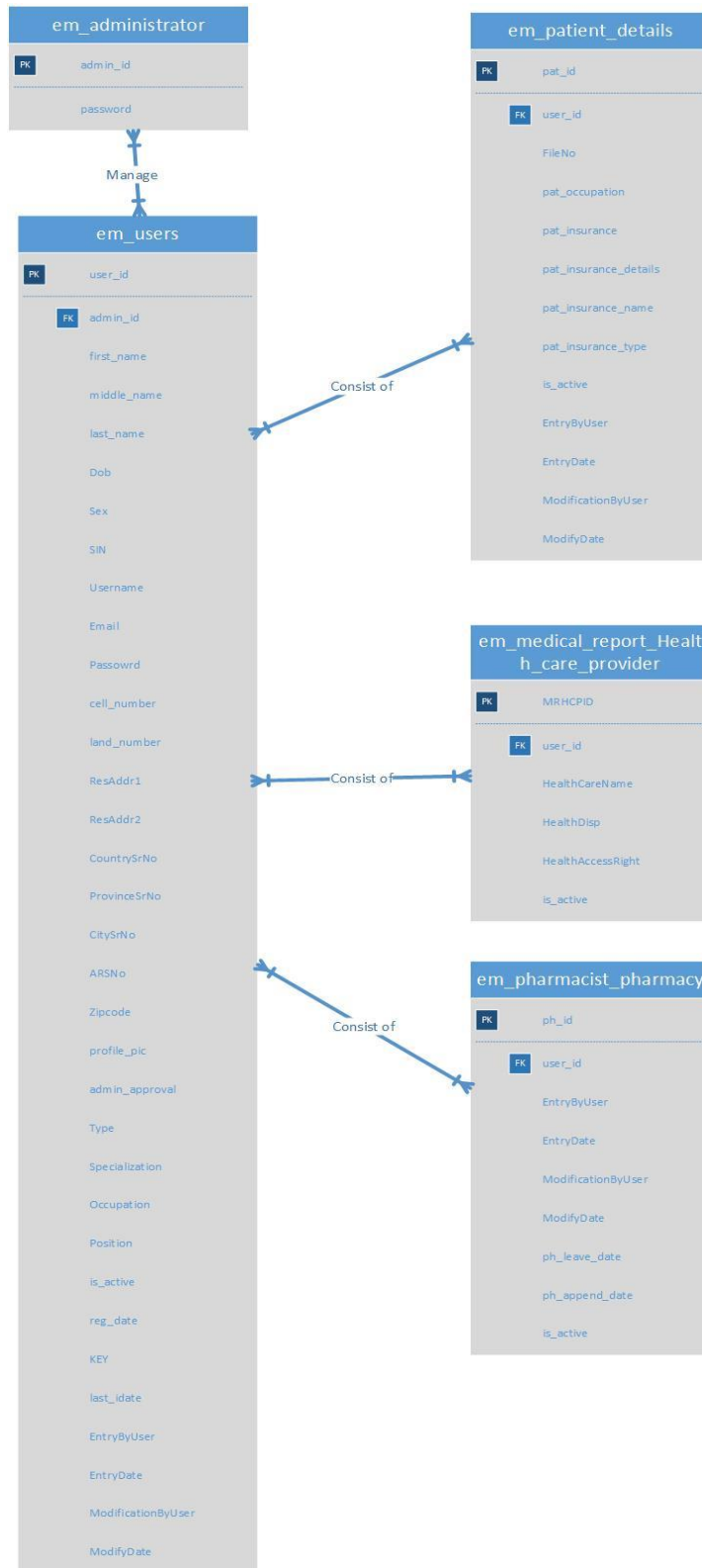

Figure 15: ER Users Diagram

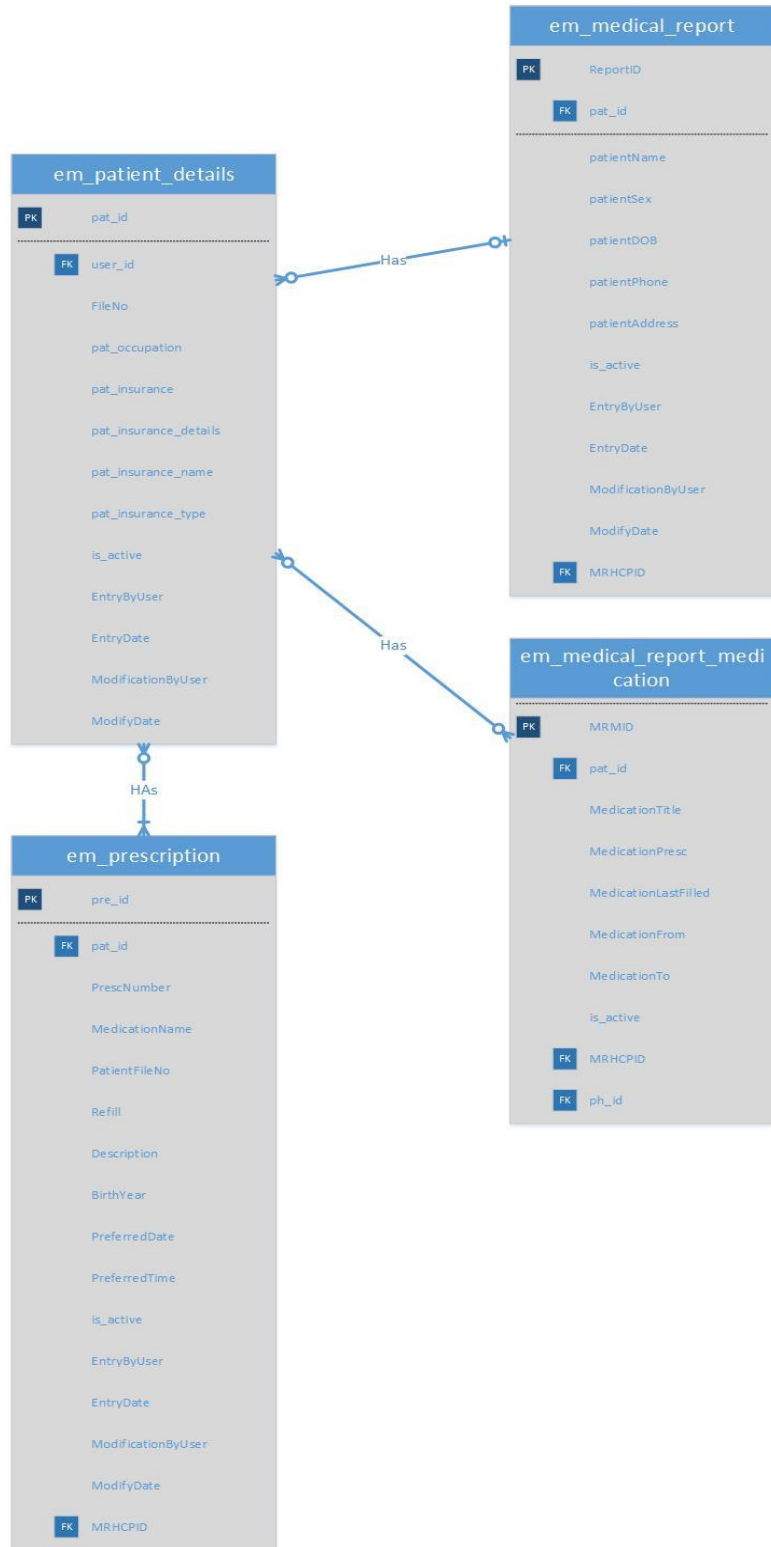

Figure 16: ER Patient Diagram

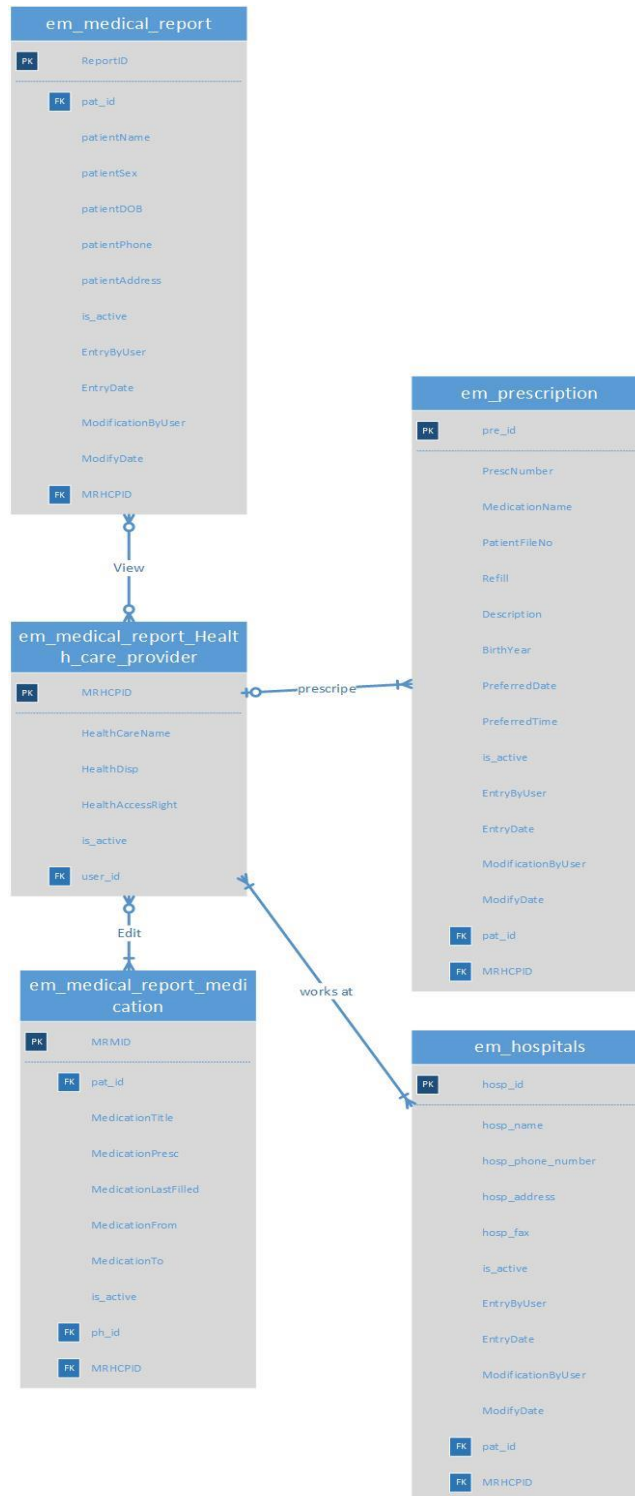

Figure 17: ER Doctor Diagram

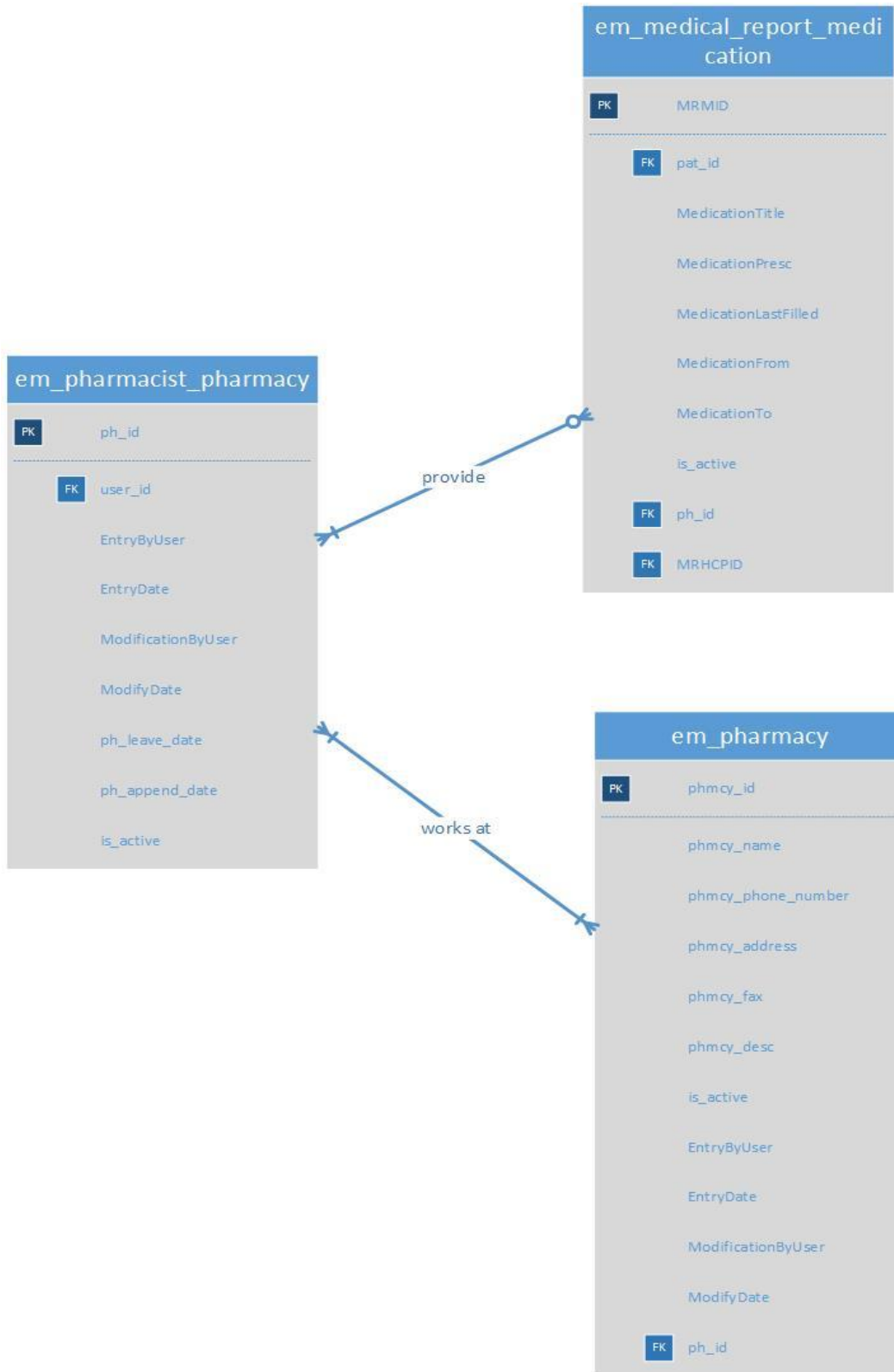

Figure 18: ER Pharmacist Diagram

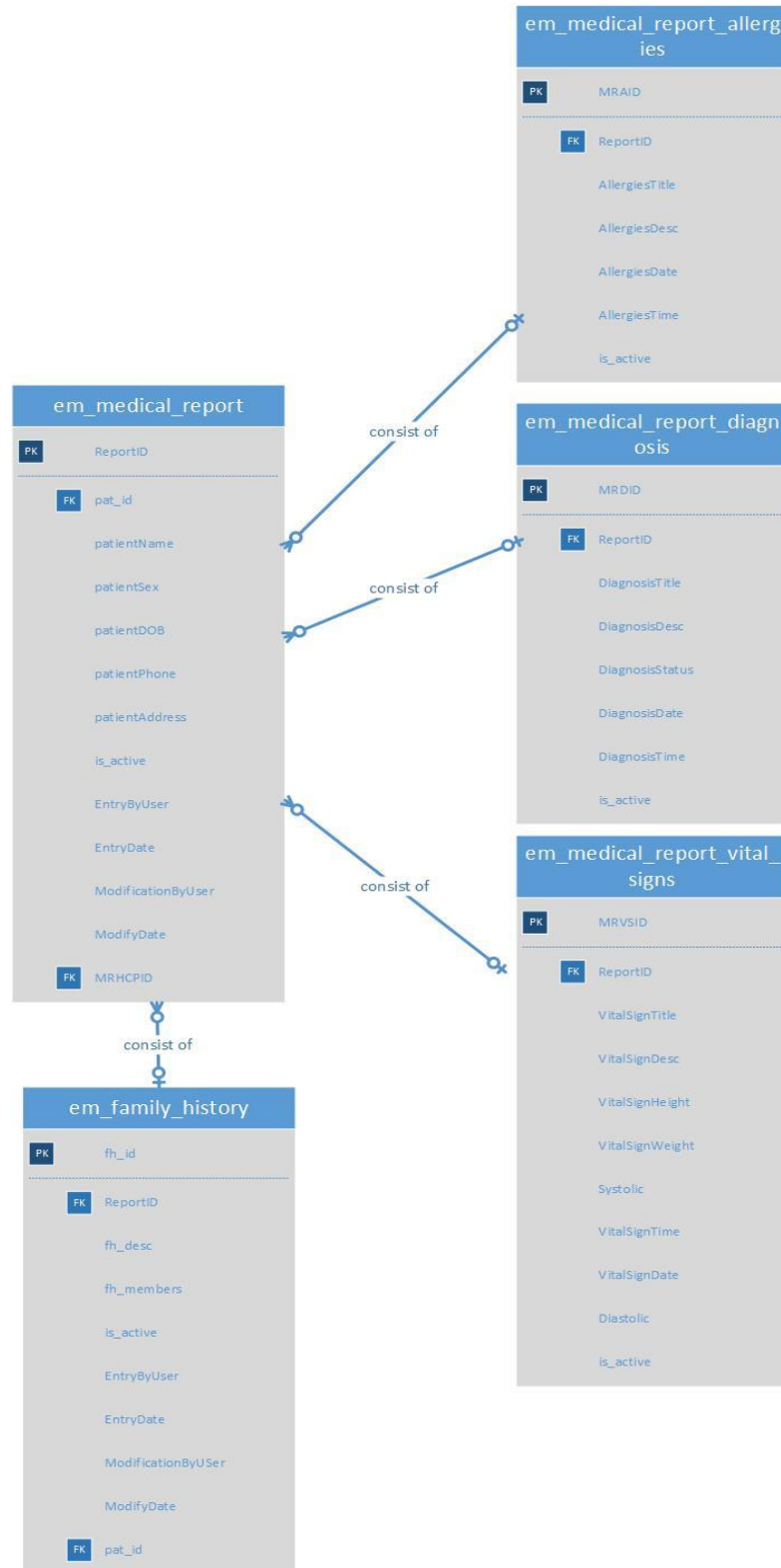

Figure 19: ER Medial Report Diagram

4.2.1 Data Dictionary

As shown in table 1, em_family_history table describes all patients' medical background information. Therefore, a table will be created for each patient.

Structure for em_family_history

Attribute	Description	Type	Null	Primary Key
fh_id	Unique identifier	int(11)	No	Yes
fh_desc	The family history description	varchar(250)	No	
pat_id	patient ID	int(11)	No	
fh_members	The members of the family	int(11)	No	
is_active	To check if the user is active or not	int(11)	No	
EntryByUser	Data entered by user	int(11)	No	
EntryDate	Date of data's entry	Date	No	
ModificationByUser	Modified data by user	int(11)	No	
ModifyDate	Date of data's modification	Date	No	
ReportID	Report ID	Int(11)	No	

Table 1: em_family_history Table

As demonstrated in table 2, em_hospitals table describes all information related to hospitals.

Structure for em_hospitals

Attribute	Description	Type	Null	Primary Key
hosp_id	Unique identifier	int(11)	No	Yes
hosp_name	Hospital name	varchar(100)	No	
hosp_phone_number	Hospital phone number	varchar(20)	No	
hosp_address	Hospital address	varchar(500)	No	
hosp_fax	Hospital fax number	varchar(20)	No	
is_active	to check if the user is active or not	varchar(2)	No	
EntryByUser	Data entered by user	int(11)	No	

EntryDate	Date of data's entry	Date	No	
ModificationByUser	Modified data by user	int(11)	No	
ModifyDate	Date of data's modification	Date	No	
MRHCPID	Doctor ID	Int(11)	No	
Pat_id	Patient ID	Int(11)	No	

Table 2: em_hospitals Table

As illustrated in table 3, em_medical_reports table describes all medical report information for each patient.

Structure for em_medical_reports

Attribute	Description	Type	Null	Primary Key
ReportID	Unique identifier	int(11)	No	Yes
Pat_id	Patent ID	int(11)	No	
PatientName	Patient's name	varchar(100)	No	
PatientSex	Patient's gender	varchar(10)	No	
PatientDOB	Patient's date of birth	Date	No	
PatientPhone	Patient's phone number	int(11)	No	
PatientAddress	Patient's address	varchar(500)	No	
is_active	To check if the user is active or not	int(11)	No	
EntryByUser	Data entered by user	int(11)	No	
EntryDate	Date of entered data	Date	No	
ModificationByUser	Data modified by user	int(11)	No	
ModifyDate	Date of modified data	Date	No	
MRHCPID	Doctor ID	Int(11)	No	

Table 3: em_medical_reports Table

As shown in table 4, em_medical_report_allergies describes all patient's allergies information.

Structure for em_medical_report_allergies

Attribute	Description	Type	Null	Primary Key
MRAID	Unique identifier	int(11)	No	Yes
ReportID	Report ID	int(11)	No	
AllergiesTitle	Title of allergy	varchar(100)	No	
AllergiesDesc	Allergy description	varchar(500)	No	
AllergiesDate	Allergy date	Date	No	
AllergiesTime	Allergy time	Time	No	
is_active	To check if the user is active or not	varchar(4)	No	

Table 4: em_medical_report_allergies Table

As demonstrated in table 5, em_medical_report_diagnosis table describes all diagnosis information taken for each patient.

Structure for em_medical_report_diagnosis

Attribute	Description	Type	Null	Primary Key
MRDID	Unique identifier	int(11)	No	Yes
ReportID	Report ID	int(11)	No	
DiagnosisTitle	The diagnosis title	varchar(100)	No	
DiagnosisDesc	The patient diagnosis description	varchar(500)	No	
DiagnosisStatus	The diagnosis status	varchar(8)	No	
DiagnosisDate	The diagnosis date	Date	No	
DiagnosisTime	The diagnosis time	Time	No	
is_active	To check if the user is active or not	varchar(4)	No	

Table 5: em_medical_report_diagnosis Table

As illustrated in table 6, em_medical_report_health_care_providers table describes all doctors' personal information.

Structure for em_medical_report_health_care_providers

Attribute	Description	Type	Null	Primary Key
MRHCPID	Unique identifier	int(11)	No	Yes
User_id	User ID	varchar(8)	No	
HealthCareName	Hospital's name	varchar(100)	No	
HealthDisp	Health discription	varchar(500)	No	
HealthAccessRight	To check if user has to right to access health description	varchar(8)	No	
is_active	To check if the user is active or not	varchar(4)	No	

Table 6: em_medical_report_health_care_providers Table

As shown in table 7, em_medical_report_medication describes all medication information prescribed to the patient.

Structure for em_medical_report_medication

Attribute	Description	Type	Null	Primary Key
MRMID	Unique identifier	int(11)	No	Yes
Pat_Id	Patient ID	int(11)	No	
MedicationTitle	The medication title	varchar(100)	No	
MedicationPresc	The medication prescription	varchar(500)	No	
MedicationLastfilled	Last date filled	Date	No	
MedicationFrom	Medication filling date	Date	No	
MedicationTo	Last date of medication use	Date	No	
is_active	To check if the user is active or not	varchar(4)	No	
Ph_id	Pharmacist ID	int(11)	No	
MRHCPID	Doctor ID	Int(11)	No	

Table 7: em_medical_report_medication Table

As demonstrated in table 8, em_medical_report_vital_signs table describes the vital signs information for each patient.

Structure for em_medical_report_vital_signs

Attribute	Description	Type	Null	Primary Key
MRVSID	Unique identifier	int(11)	No	Yes
VitalSignTitle	The title of vital signs	varchar(100)	No	
VitalSignDesc	The vital signs description	varchar(500)	No	
VitalHeight	The patient's height	varchar(10)	No	
VitalWeigth	The patient's weight	varchar(10)	No	
Systolic	The patient's systolic	varchar(100)	No	
Diastolic	The patient's diastolic	varchar(100)	No	
VitalSignDate	The report date	Date	No	
VitalSignTime	The report time	Time	No	
is_active	To check if the user is active or not	varchar(4)	No	
ReportID	Report ID	Int(11)	No	

Table 8: em_medical_report_vital_signs Table

As illustrated in table 9, em_patient_details table describes all patient's medical and personal information.

Structure for em_patient_details

Attribute	Description	Type	Null	Primary Key
pat_id	Unique identifier	int(11)	No	Yes
user_id	User ID	int(200)	No	
FileNo	Patient's file number	varchar(20)	No	
pat_occupation	Patient's occupation	varchar(200)	No	
pat_insurance	Patient's insurance	varchar(200)	No	
pat_insurance_details	Patient's insurance details	varchar(200)	No	
pat_insurance_name	Patient's insurance name	varchar(10)	No	
pat_insurance_type	Patient's insurance type	varchar(200)	No	
is_active	To check if the user is active or not	varchar(2)	No	

EntryByUser	Entered data by user	int(11)	No	
EntryDate	Date of entered data	Date	No	
ModificationByUser	Modified data by user	int(11)	No	
ModifyDate	Date of modified data	Date	No	

Table 9: em_patient_details Table

As shown in table 10, em_pharmacy table describes all pharmacies' information.

Structure for em_pharmacy

Attribute	Description	Type	Null	Primary Key
phmcy_id	Unique identifier	int(11)	No	Yes
phmcy_name	Pharmacy name	varchar(50)	No	
phmcy_phone_number	Pharmacy phone number	int(13)	No	
phmcy_address	Pharmacy address	varchar(100)	No	
phmcy_fax	Pharmacy fax number	int(13)	No	
phmcy_desc	Pharmacy description	varchar(100)	No	
is_active	To check if the user is active or not	varchar(10)	No	
EntryByUser	Data entered by user	int(11)	No	
EntryDate	Date of entered data	Date	No	
ModificationByUser	Modified data by user	int(11)	No	
ModifyDate	Date of modified data	Date	No	
Ph_id	Pharmacist ID	Int(11)	No	

Table 10: em_pharmacy Table

Em_pharmacy_location (table 11) describes the location of each pharmacy.

Structure for em_pharmacy_location

Attribute	Description	Type	Null	Primary Key
PhID	Unique identifier	int(11)	No	Yes
PhLocation	Pharmacy location	varchar(100)	No	
is_active	To check if the user is active or not	varchar(10)	No	
EntryByUser	Data entered by user	int(11)	No	
EntryDate	Date of entered data	Date	No	

Table 11: em_pharmacy_location Table

Em_prescription table (table 12) describes each prescription prescribed by the doctor to the patient.

Structure for em_prescription

Attribute	Description	Type	Null	Primary Key
pre_id	Unique identifier	int(11)	No	Yes
PrescNumber	Prescription number	varchar(50)	No	
MedicationName	Medication name	Text	No	
Pat_Id	Patient ID	int(11)	No	
PatientFileNo	Patient file number	varchar(64)	No	
MRHCPID	Doctor ID	int(11)	No	
Ph_id	Pharmacist ID	int(11)	No	
Refill	Numbers of refill	varchar(50)	No	
Description	Medication usage description	Text	No	
BirthYear	Patient's date of birth	varchar(16)	No	
PreferredDate	Preferred pick up date	Date	No	
PreferredTime	Preferred pick up time	Time	No	
is_active	To check if the user is active or not	varchar(10)	No	
EntryByUser	Data entered by user	int(11)	No	
EntryDate	Date of entered data	Date	No	
ModificationByUser	Data modified by user	int(11)	No	
ModifyDate	Date of modified data	Date	No	

Table 12: em_prescription Table

Em_types table (table 13) describes the types of users who are using the applications such as, doctor, pharmacist, patient and admin.

Structure for em_types

Attribute	Description	Type	Null	Primary Key
type_id	Unique identifier	Double	No	Yes
Name	User's name	varchar(200)	No	

Description	Description of user	Text	No	
is_active	To check if the user is active or not	varchar(2)	No	
EntryByUser	Entered data by user	int(11)	No	
EntryDate	Date of entered data	Date	No	
ModificationByUser	Modified data by user	int(11)	No	
ModifyDate	Date of modified data	Date	No	

Table 13: em_types Table

Em_users table (table 14) describes the users' information in details.

Structure for em_users

Attribute	Description	Type	Null	Primary Key
user_id	Unique identifier	Double	No	Yes
first_name	User's first name	varchar(200)	No	
middle_name	User's middle name	varchar(200)	No	
last_name	User's last name	varchar(200)	No	
Dob	Date of birth	Date	No	
Sex	User's gender	varchar(10)	No	
SIN	User's social insurance number	varchar(50)	No	
Username	Sign in user name	varchar(200)	No	
Email	User's email	varchar(500)	No	
Password	Sign in password	varchar(500)	No	
cell_number	User's cell phone number	varchar(200)	No	
land_number	User's land number	varchar(200)	No	
ResAddr1	Residential address 1	varchar(200)	No	
ResAddr2	Residential address	varchar(255)	Yes	
BranchName	Pharmacy's branch name	Text	No	
Nationality	User's nationality	int(11)	No	
CountrySrNo	Country serial number	int(11)	No	
ProvinceSrNo	Province serial number	int(11)	No	
CitySrNo	City serial number	int(11)	No	
ARSrNo	User's serial number	int(11)	No	
Zipcode	User's zip code	varchar(50)	No	

profile_pic	User's profile picture	varchar(1000)	No	
admin_approval	Admin's approval	varchar(4)	No	
Type	User's type	int(11)	No	
specialization	User's specialization(doctor)	varchar(50)	No	
Occupation	User's occupation	varchar(50)	No	
Position	User's position	varchar(50)	No	
is_active	To check if the user is active	varchar(2)	No	
reg_date	Registration date	Datetime	No	
KEY	Random unique identity number	varchar(20)	No	
last_idate	Last login date	Datetime	No	
EntryByUser	Data entered by user	int(11)	No	
EntryDate	Date of entered data	Date	No	
ModificationByUser	Modified data by user	int(11)	No	
ModifyDate	Date of modified data	Date	No	
Admin_id	Administrator ID	Int(11)	No	

Table 14: em_users Table

Em_pharmacist_pharmacy table (table 15) describes all details related to pharmacist.

Structure for em_pharmacist_pharmacy

Attribute	Description	Type	Null	Primary Key
PhID	Unique identifier	int(11)	No	Yes
user_id	User ID	varchar(100)	No	
is_active	To check if the user is active or not	varchar(10)	No	
EntryByUser	Data entered by user	int(11)	No	
EntryDate	Date of entered data	Date	No	
ModificationByUser	Modified data by user	int(11)	No	
ModifyDate	Date of modified data	Date	No	
Ph_append_date	Date of pharmacist date of work	Date	No	
Ph_leave_date	Date of pharmacist date of work	Date	No	

Table 15: em_pharmacist_pharmacy Table

4.3 Web Services Implemented for the Prototype

API link: <http://www.electronicmedical.info/em/api/api.php>

The API link is appended with a query string which changes according to the type of request. The query string mainly contains three things apart from other data.

- Class name: contains the name of the class in which the method is written.
- Method: the name of the method to be called.
- Sessionid: the unique sessionid generated during the login.

Other parameters are passed according to the type of request such as insert, update and delete.

4.3.1 Login

Class Name: Authenticate

Method: login_check

URL:

[http://www.electronicmedical.info/api/api.php?class=authenticate&method=login_mob&login_param={"username":"admin","userpassword":"123"}](http://www.electronicmedical.info/api/api.php?class=authenticate&method=login_mob&login_param={)

Parameters: username, password

As soon as the user logs in, a unique session id is generated for this user using which s/he can call the API link and fetch the required data in JSON. The API link is as follows:

Definition:

String sessionId, String profile, String fileNo, String userId, String fname, String mname, String lname, String dob, String gender, String uname, String email, String sin, String phonenumber, String landnumber, String address, String address2, String nationality,

String isactive, String city, String province, String country, String zipCode, String area,
String usertype, String specialization, String position, String occupation;

Return JSON:

```
{ "sessionid": "5688e8cb3f5cf", "Profile": { "user_id": "10", "first_name": "aaa",  
"middle_name": "", "last_name": "aaa", "dob": "1999-08  
01", "sex": "Male", "username": "Doc01", "email": "m.a.a@gmail.com", "SIN": "979799979",  
"cell_number": "9028782345", "land_number": ""  
", "Address1": "727Robiestreet", "Address2": "", "Nationality": "0", "is_active": "1", "user_ty  
pe": "Doctor", "CityName": "Halifax", "ProvinceName": "N.S", "CountryName": "Canada", "zipcod  
e": "B3R  
2A1", "AreaName": "Downtown", "SpecializationName": "FamilyDoctor", "PositionName": null,  
"OccupationName": "Doctor" } }
```

4.3.2 Logout

Class Name: Logout

Method: logout_user

URL:

http://www.electronicmedical.info/api/api.php?class=logout&method=logout_user

Parameters: none

Definition: String msg;

Return JSON:

```
{ "message": "Successfully logged out" }
```

4.3.3 Select Data (From any table – General Select Service)

Class Name: select

Method: select_data

URL:

http://www.electronicmedical.info/api/api.php?class=select&method=select_data&table_name=em_users&condition={%22is_active%22:%221%22}&username=admin&userpassword=123

Parameters: table_name, condition

Definition:

String userId, String fname, String mname, String lname, String gender, String uname, String email, String website, String password, String phonenumber, String address, String address2, String isactive, String citySN, String provinceSN, String countrySN, String zipCode, String areaSR, String BrSN, String adminAp, String roleId, String regActive;

Return JSON:

```
[{"user_id":"1","first_name":"Nouf","middle_name":"a","last_name":"Alarnous","sex":"F","username":"Nouf","email":"nouf.arn@gmail.com","website":"www.electronicmedical.info/em","password":"202cb962ac59075b964b07152d234b70","cell_number":"9023137689","ResAddr1":"898 ClytonPark","ResAddr2":"Line No. 2","CountrySrNo":"1","ProvinceSrNo":"1","CitySrNo":"1","ARSrNo":"3","zipcode":"B3T2B1","BrSrNo":"1","admin_approval":"Y","role_id":"1","is_active":"1","reg_active":"Y"}]
```

4.3.4 Insert Data (For any table – General Insert Service)

Class Name: insert

Method: add_data

URL:

http://www.electronicmedical.info/api/api.php?class=insert&method=add_data&json={%22table_name%22:%22em_users%22,%22data%22:{%22first_name%22:%22My_name%22}}&username=admin&userpassword=123

Parameters: table_name, data_to_insert

Definition: String msg, String insertId;

Return JSON example:

```
{"message":"Data Inserted Successfully","insert_id":18}
```

4.3.5 Update Data (For any table – General Update Service)

Class Name: Update

Method: update_data

URL:[http://www.electronicmedical.info/api/api.php?class=update&method=update_data&json={"table_name":"em_users","data":{"first_name":"Nouf"},"condition":{"user_id":"1"}}&username=admin&userpassword=123](http://www.electronicmedical.info/api/api.php?class=update&method=update_data&json={)

Parameters: table_name, data,condition

Definition: String msg;

Return JSON example:

```
{"message":"Data Updated Successfully"}
```

4.3.6 Delete Data (From Any Table – General Delete Service)

Class Name: delete_data

Method: delete_data

URL:
http://www.electronicmedical.info/api/api.php?class=delete_data&method=delete_data&table_name=em_users&condition={%22user_id%22:%2215%22}&username=admin&userpassword=123

Parameters: table_name, condition

Definition: String msg;

Return JSON:

```
{"message":"Data Deleted Successfully"}
```

4.3.7 Registration

Class Name: authenticate

Method: register

URL:

[http://www.electronicmedical.info/api/api.php?class=authenticate&method=register&json={\"first_name\":\"Naif\",\"middle_name\":\"H\",\"last_name\":\"Alsam\",\"dob\":\"2015-11-12\",\"sex\":\"M\",\"SIN\":\"1245\",\"username\":\"ASDA\",\"password\":\"123\",\"email\":\"asbc@hotmail.com\",\"cell_number\":\"9026543210\",\"ResAddr1\":\"Gladstone\",\"ResAddr2\":\"asd\",\"CountrySrNo\":\"1\",\"ProvinceSrNo\":\"2\",\"CitySrNo\":\"3\",\"ARSrNo\":\"2\",\"zipcode\":\"382480\",\"Type\":\"2\",\"specialization\":\"Dentist\",\"occupation\":\"Doctor\",\"BranchName\":\"Robie Street\",\"position\":\"null\",\"reg_date\":\"2015-05-20\",\"last_idate\":\"2015-05-15\"}](http://www.electronicmedical.info/api/api.php?class=authenticate&method=register&json={\)

Parameters: json_data

Definition: String msg;

Return JSON:

If same Username: {\"message\":\"Username Already Exist\"}

If same Email: {\"message\":\"Email ID Already Exist\"}

If Successful: {\"message\":\" Registration Successful\"}

If Failure: {\"message\":\" Error while registration. Please try again\"}

4.3.8 User Types Master

Class Name: select

Method: get_user_type

URL:

[http://www.electronicmedical.info/api/api.php?class=select&method=get_user_type&condition={\"is_active\":\"1\"}&username=admin&userpassword=123](http://www.electronicmedical.info/api/api.php?class=select&method=get_user_type&condition={\)

Parameters: json_data

Definition:

String typeId, String name, String description, String isactive;

Return JSON:

```
[{"type_id":"2","name":"Doctor","description":"Doctor
User","is_active":"1"}, {"type_id":"3","name":"Patient","description":"Patient
User","is_active":"1"}, {"type_id":"4","name":"Pharmacist","description":"Pharmacist
User","is_active":"1"}, {"type_id":"1","name":"Super Admin","description":"Manages all
modules of the application","is_active":"1"}]
```

4.3.9 Patient Search

Class Name: users

Method: get_patient

URL:

[http://www.electronicmedical.info/api/api.php?class=users&method=get_patient&condition={"first_name":"Su","last_name":"Als","file_number":"PA"}&username=admin&userpassword=123](http://www.electronicmedical.info/api/api.php?class=users&method=get_patient&condition={)

Parameters: json_data

Definition:

String fileNo, String userId, String fname, String lname, String mname, String dob, String gender, String uname ,String email, String sin, String phonenumber, String landnumber, String address, String address2, String nationality, String isactive, String usertype, String city, String province, String country, String zipCode, String Area, String specialization, String position, String occupation;

Return JSON:

```
[{"FileNo":"PAT_012LP","user_id":"7","first_name":"Sultan","last_name":"Alsabhan","middle_name":"","dob":"0000-00-
```

```
00","sex":"Female","username":"Sultan","email":"sms.s1@hotmail.com","SIN":"","cell_number":"902432675","land_number":"","Address1":"787ProspectBayRd","Address2":"","Nationality":"Saudi","is_active":"1","user_type":"Patient","CityName":"Halifax","ProvinceName":"N.S","CountryName":"Canada","zipcode":"B3T2C1","AreaName":"Prospect","SpecializationName":"Patient","PositionName":"Patient","OccupationName":"Student"]}]
```

4.3.10 Prescription Entry

Class Name: insert

Method: add_data

URL:

[http://www.electronicmedical.info/api/api.php?class=insert&method=add_data&json={\"table_name\":\"em_prescription\",\"data\":{\"PrescNumber\":\"25ASGH000\",\"MedicationName\":\"TaflonFX\",\"PatientID\":\"2\",\"PatientFileNo\":\"25DF\",\"PharmacistID\":\"3\",\"Refill\":\"3\",\"Description\":\"Daily%20%20Dosage\",\"is_active\":\"1\",\"EntryByUser\":\"1\",\"EntryDate\":\"2015-08-25\",\"ModificationByUser\":\"2\",\"ModifyDate\":\"2015-08-25\"}}&username=admin&userpassword=123](http://www.electronicmedical.info/api/api.php?class=insert&method=add_data&json={\)

Parameters: json_data

Definition: String msg, String insertId;

Return JSON:

```
{\"message\":\"Data Inserted Successfully\",\"insert_id\":1}
```

4.3.11 Get My Prescription Ready

Class Name: insert

Method: add_data

URL:

[http://www.electronicmedical.info/api/api.php?class=insert&method=add_data&json={\"table_name\":\"em_prescription\",\"data\":{\"PrescNumber\":\"25ASGH000\",\"MedicationName\":\"Agitex\",\"PatientID\":\"2\",\"DoctorID\":\"2\",\"PharmacistID\":\"3\",\"Refill\":\"3\",\"BirthYear\":\"2000-05-12\",\"PreferredDate\":\"2008-05-12\",\"PreferredTime\":\"05-05-12\",\"is_active\":\"1\",\"EntryByUser\":\"1\",\"EntryDate\":\"2015-08-25\"}}&username=admin&userpassword=123](http://www.electronicmedical.info/api/api.php?class=insert&method=add_data&json={\)

Parameters: json_data

Definition: String msg, String insertId;

Return JSON:

```
{\"message\":\"Data Inserted Successfully\",\"insert_id\":1}
```

4.3.12 Medication Entry

Class Name: insert

Method: add_data

URL:

[http://www.electronicmedical.info/api/api.php?class=insert&method=add_data&json={\"table_name\":\"em_medication\",\"data\":{\"med_name\":\"Flacon\",\"med_desc\":\"EarDrops\",\"med_from\":\"2011-06-23\",\"med_to\":\"2015-01-12\",\"med_dosage\":\"3\",\"med_desc_no\":\"Daily%20%20Dosage\",\"is_active\":\"1\",\"EntryByUser\":\"1\",\"EntryDate\":\"2015-08-25\",\"ModificationByUser\":\"2\",\"ModifyDate\":\"2015-08-25\"}}&username=admin&userpassword=123](http://www.electronicmedical.info/api/api.php?class=insert&method=add_data&json={\)

Parameters: json_data

Definition: String msg, String insertId;

Return JSON:

```
{\"message\":\"Data Inserted Successfully\",\"insert_id\":1}
```

4.3.13 Medication Search

Class Name: users

Method: get_medication

URL:

[http://www.electronicmedical.info/api/api.php?class=users&method=get_medication&condition={"med_name":"Al"}&username=admin&userpassword=123](http://www.electronicmedical.info/api/api.php?class=users&method=get_medication&condition={)

Parameters: json_data

Definition:

String MedicationID, String MedicationTitle, String MedicationPresc, String MedicationLastBilled, String MedicationFrom, String MedicationTo, String MedicationDos, String MedicationPN, String isactive, String EntryBU, String ModificationBU;

```
String medlastbilled = new SimpleDateFormat("yyyy-MM-dd").format(new Date());
```

```
String medfrom= new SimpleDateFormat("yyyy-MM-dd").format(new Date());
```

```
String medto = new SimpleDateFormat("yyyy-MM-dd").format(new Date());
```

```
String entrydate = new SimpleDateFormat("yyyy-MM-dd").format(new Date());
```

```
String modifydate= new SimpleDateFormat("yyyy-MM-dd").format(new Date());
```

Return JSON:

```
[{"med_id":"1","med_name":"Almosin  
VT+","med_desc":"KADGMigh","med_from":"2015-06-05","med_to":"2016-06-  
06","med_dosage":"Daily 2  
times","med_desc_no":"12121","is_active":"1","EntryByUser":"1","EntryDate":"2015-  
06-06","ModificationByUser":"1","ModifyDate":"2015-06-06"}]
```

4.3.14 Update Insurance

Class Name: Update

Method: update_data

URL:

[http://www.electronicmedical.info/api/api.php?class=update&method=update_data&json={\"table_name\":\"em_patient_details\",\"data\":{\"pat_occupation\":\"Self Employed\",\"pat_insurance\":\"EM_2015VC15\",\"pat_insurance_details\":\"Cowan\",\"pat_insurance_type\":\"2\",\"is_active\":\"1\",\"ModificationByUser\":\"1\",\"ModifyDate\":\"2015-06-27\"},\"condition\":{\"user_id\":\"1\"}}&username=admin&userpassword=123](http://www.electronicmedical.info/api/api.php?class=update&method=update_data&json={\)

Parameters: table_name, data, condition

Definition: String msg;

Return JSON:

```
{\"message\":\"Data Updated Successfully\"}
```

4.3.15 Search User (Pharmacist/Patient)

Class Name: users

Method: search_user

URL:

[http://www.electronicmedical.info/api/api.php?class=users&method=search_user&condition={\"dob\":\"\",\"name\":\"Nouf\",\"sin\":\"\"}&username=admin&userpassword=123](http://www.electronicmedical.info/api/api.php?class=users&method=search_user&condition={\)

Parameters: table_name, dob, sin, name

Definition: String msg;

Return JSON:

```
{\"message\":\"Data Updated Successfully\"}
```

4.3.16 Forgot Password

Class Name: Update

Method: forgot_pass

URL:

[http://www.electronicmedical.info/api/api.php?class=update&method=forgot_pass&json={\"table_name\":\"em_users\",\"data\":{\"email\":\"missnono14@hotmail.com\"},\"condition\":{\"is_active\":\"1\"}}&username=admin&userpassword=123](http://www.electronicmedical.info/api/api.php?class=update&method=forgot_pass&json={\)

Parameters: table_name, data,condition

Definition: String msg;

Return JSON:

```
{\"message\":\"OTP Sent Successfully\"}
```

4.3.17 Change Password

Class Name: Update

Method: change_pass

URL:

[http://www.electronicmedical.info/api/api.php?class=update&method=change_pass&json={\"table_name\":\"em_users\",\"data\":{\"KEY\":\"12asadad\",\"password\":\"123\"},\"condition\":{\"is_active\":\"1\"}}&username=admin&userpassword=123](http://www.electronicmedical.info/api/api.php?class=update&method=change_pass&json={\)

Parameters: table_name, data,condition

Definition: String msg;

Return JSON:

If success: {\"message\":\"Password changed Successfully\"}

If fail: {\"message\":\"May be your key is invalid or expired. Request new one\"} or {\"message\":\"Error! Please try again\"}

4.3.18 Verify Key

Class Name: Update

Method: verify_key

URL:

[http://www.electronicmedical.info/api/api.php?class=update&method=verify_key&json={\"data\":{\"key\":\"144152038\"},\"condition\":{\"is_active\":\"1\"}}&username=admin&userpassword=123](http://www.electronicmedical.info/api/api.php?class=update&method=verify_key&json={\)

Parameters: table_name, data, condition

Definition: String msg;

Return JSON:

If fail: {\"message\":\"Invalid Key\"}

If success: {\"message\":\"Key Matching\"}

If empty: {\"message\":\"Key cannot be empty\"}

4.3.19 File Upload

Class Name: Update

Method: File Upload

URL : <http://www.electronicmedical.info/upload.php>

Parameters: table_name, data, condition

Report type: radiology, medical, laboratory

Definition: String msg;

Return JSON:

{\"message\":\"File Uploaded Successfully\"}

4.3.20 Get Reports

Class Name: Select

Method: Get Report

URL:

[http://www.electronicmedical.info/api/api.php?class=select&method=get_reports&condition={"user_id":"2","report_type":"medical"}&username=admin&userpassword=123](http://www.electronicmedical.info/api/api.php?class=select&method=get_reports&condition={)

Parameters: table_name, data, condition

Definition:

String reportId, String userId, String type, String reportF, String reportDet, String reportType, String isactive, String EntryBU, String ModificationBU, String reporttime;

String reportdate = new SimpleDateFormat("yyyy-MM-dd").format(new Date());

String entrydate = new SimpleDateFormat("yyyy-MM-dd").format(new Date());

String modifydate = new SimpleDateFormat("yyyy-MM-dd").format(new Date());

Return JSON:

```
[{"report_id":"5","user_id":"2","type":"","report_file":"http://www.electronicmedical.info/uploads/1440275491_emergency-clip-art-545396.jpg","report_date":"0000-00-00","report_time":"00:00:00","report_details":"","report_type":"medical","is_active":"1","EntryByUser":"1","EntryDate":"2015-08-23","ModificationByUser":"1","ModifyDate":"2015-08-23"}]
```

4.3.21 Update Medical Report - Diagnosis Data

Class Name: Update

Method: update_data

URL:

[http://www.electronicmedical.info/api/api.php?class=update&method=update_data&json={\"table_name\": \"em_medical_report_diagnosis\", \"data\": {\"DiagnosisTitle\": \"10\", \"DiagnosisTitle\": \"DIVYAPATEL\", \"DiagnosisDesc\": \"DescriptionGoesHere\", \"DiagnosisDate\": \"2015-09-09\", \"DiagnosisTime\": \"20:20:20\"}, \"condition\": {\"UID\": \"561a27f2\", \"MRDID\": \"5\"}}&username=admin&userpassword=123](http://www.electronicmedical.info/api/api.php?class=update&method=update_data&json={\)

Parameters: table_name, data, UniqID, DiagnosisRowID

Definition: String msg;

Return JSON:

```
{\"message\": \"Data Updated Successfully\"}
```

4.3.22 Update Medical Report - Allergies

Class Name: Update

Method: medical_report

URL:

[http://www.electronicmedical.info/api/api.php?class=update&method=update_data&json={\"table_name\": \"em_medical_report_allergies\", \"data\": {\"AllergiesTitle\": \"DIVYAPATEL\", \"AllergiesDesc\": \"DescriptionGoesHere\", \"AllergiesDate\": \"2015-09-09\", \"AllergiesTime\": \"20:20:20\"}, \"condition\": {\"UID\": \"561a27f2\", \"MRAID\": \"5\"}}&username=admin&userpassword=123](http://www.electronicmedical.info/api/api.php?class=update&method=update_data&json={\)

Parameters: table_name, data, UniqID, AllergyRowID

Definition: String msg;

Return JSON:

```
{\"message\": \"Data Updated Successfully\"}
```

4.3.23 Update Medical Report - HealthCareProviders

Class Name: Update

Method: medical_report

URL:

[http://www.electronicmedical.info/api/api.php?class=update&method=update_data&json={\"table_name\":\"em_medical_report_health_care_providers\",\"data\":{\"HealthCareName\":\"DIVYAPATEL\",\"HealthDisp\":\"DescriptionGoesHere\"},\"condition\":{\"UID\":\"561a27f2\",\"MRHCPID\":\"5\"}}&username=admin&userpassword=123](http://www.electronicmedical.info/api/api.php?class=update&method=update_data&json={\)

Parameters: table_name, data,UniqID,HealthCareProvidersRowID

Definition: String msg;

Return JSON:

```
{\"message\":\"Data Updated Successfully\"}
```

4.3.24 Update Medical Report - Medication Data

Class Name: Update

Method: medical_report

URL:

[http://www.electronicmedical.info/api/api.php?class=update&method=update_data&json={\"table_name\":\"em_medical_report_medication\",\"data\":{\"MedicationTitle\":\"DIVYAPATEL\",\"MedicationPresc\":\"DescriptionGoesHere\",\"MedicationLastBilled\":\"2015-02-22\",\"MedicationFrom\":\"2015-02-23\",\"MedicationTo\":\"2015-05-14\"},\"condition\":{\"UID\":\"561a27f2\",\"MRMID\":\"5\"}}&username=admin&userpassword=123](http://www.electronicmedical.info/api/api.php?class=update&method=update_data&json={\)

Parameters: table_name, data,UniqID,MedicationRowID

Definition: String msg;

Return JSON:

```
{\"message\":\"Data Updated Successfully\"}
```

4.3.25 Update Medical Report - Vital Signs

Class Name: Update

Method: medical_report

URL:

[http://www.electronicmedical.info/api/api.php?class=update&method=update_data&json={\"table_name\":\"em_medical_report_vital_signs\",\"data\":{\"VitalSignTitle\":\"DIVYAPA TEL\",\"VitalSignDesc\":\"DescriptionGoesHere\",\"VitalHeight\":\"23\",\"VitalWidth\":\"14\",\"Systolic\":\"21\",\"Diastolic\":\"11\",\"VitalSignDate\":\"2015-02-02\",\"VitalSignTime\":\"12:12:12\"},\"condition\":{\"UID\":\"561a27f2\",\"MRVSID\":\"5\"}}&username=admin&userpassword=123](http://www.electronicmedical.info/api/api.php?class=update&method=update_data&json={\)

Parameters: table_name, data,UniqID,VitalSignRowID

Definition: String msg;

Return JSON:

{\"message\":\"Data Updated Successfully\"}

4.3.26 Get Medical Report By Report ID

Class Name: Select

Method: Select data

URL:

[http://www.electronicmedical.info/api/api.php?class=select&method=get_medical_report&table_name=em_medical_reports&condition={\"ReportID\":\"8\"}&username=admin&userpassword=123](http://www.electronicmedical.info/api/api.php?class=select&method=get_medical_report&table_name=em_medical_reports&condition={\)

Parameters: table_name, data, condition

Definition:

String userId, String patientId, String patientName, String patientSex, String patientDOB,

String patientPhone, String patientAddress, String diagnosisId, String diagnosisTitle,

String diagnosisDesc, String diagnosisStaus, String diagnosistime, String medicationId, String medicationTitle, String medicationPresc, String healthCareId, String healthCareName, String healthDisp, String healthAccessRight, String vitalSignId, String vitalSignTitle, String vitalSignDesc String vitalHeight, String vitalWidth, , String systolic, String diastolic, String allergiesID, String allergiesTitle, String allergiesDesc, String allergiestime;

String diagnosisdate = new SimpleDateFormat("yyyy-MM-dd").format(new Date());

String medlastbilled = new SimpleDateFormat("yyyy-MM-dd").format(new Date());

String medfrom= new SimpleDateFormat("yyyy-MM-dd").format(new Date());

String medto = new SimpleDateFormat("yyyy-MM-dd").format(new Date());

String allergiesdate = new SimpleDateFormat("yyyy-MM-dd").format(new Date());

Return JSON:

```
{ "UID": "561a27f3", "PatientID": "100", "PatientName": "Nuha Sa", "PatientSex": "M", "PatientDOB": "1992-03-25", "PatientPhone": "9024346162", "PatientAddress": "Address Risk", "DiagnosisID": "[7,8]", "Diagnosis": [{"DiagnosisID": "5", "DiagnosisTitle": "DupMy DiagnosisNameHere", "DiagnosisDesc": "DupMyDescriptionGoesHere", "DiagnosisStaus": "Resolved", "DiagnosisDate": "2015-10-09", "DiagnosisTime": "20:20:20"}, {"DiagnosisID": "25", "DiagnosisTitle": "DupYourDiagnosisNameHere", "DiagnosisDesc": "DupYourDescriptionGoesHere", "DiagnosisStaus": "Ongoing", "DiagnosisDate": "2016-08-09", "DiagnosisTime": "20:20:20"}], "MedicationID": "[7,8]", "Medication": [{"MedicationID": "44", "MedicationTitle": "DupMyTitleGoesHere", "MedicationPresc": "DupMyyyyMedicationPrescGoesHere", "MedicationLastBilled": "2015-07-30", "MedicationFrom": "2015-05-09", "MedicationTo": "2015-06-09"}, {"MedicationID": "80", "MedicationTitle": "DupYoursadTitleGoesHere", "MedicationPresc": "DupYourssMedicationPrescGoesHere", "MedicationLastBilled": "2015-09-
```

```

22","MedicationFrom":"2015-11-09","MedicationTo":"2015-06-
09"}],{"HealthCareID":"11","HealthCareName":"DupMyHealthNameHer
e","HealthDisp":"DupMDyDispGoesHere","HealthAccessRight":"N"},{"HealthCareID":
"10","HealthCareName":"DupYourHealthNameHere","HealthDisp":"DupYourDispGoes
Here","HealthAccessRight":"Y"}],{"VitalSignID":"[7,8]","VitalSign":[{"VitalSignID":"7
8","VitalSignTitle":"DupMasdTitleGoesHere","VitalSignDesc":"DupMyasdaskdjDescG
oesHere","VitalHeight":"10","VitalWidth":"205","Systolic":"44","Diastolic":"66"},{"Vit
alSignID":"4","VitalSignTitle":"DupYouaasdTitleGoesHere","VitalSignDesc":"DupYou
asdDescGoesHere","VitalHeight":"40","VitalWidth":"25","Systolic":"92","Diastolic":"4
14"}],{"AllergiesID":"[7,8]","Allergies":[{"AllergiesID":"66","AllergiesTitle":"DupYour
aasdAllergiesTitle","AllergiesDesc":"DupYoursadadaAllergyDESC","AllergiesDate":"2
015-07-
07","AllergiesTime":"05:05:05"},{"AllergiesID":"55","AllergiesTitle":"DupMyAllergies
Title","AllergiesDesc":"DupMyyyasdAllergyDESC","AllergiesDate":"2015-07-
07","AllergiesTime":"05:05:05"}]}

```

4.3.27 Get Medical Report By Patient ID

Class Name: Select

Method: Select data

URL:

[http://www.electronicmedical.info/api/api.php?class=select&method=get_medical_report&table_name=em_medical_reports&condition={"PatientID":"100"}&username=admin&userpassword=123](http://www.electronicmedical.info/api/api.php?class=select&method=get_medical_report&table_name=em_medical_reports&condition={)

Parameters: table_name, data, condition

Definition:

String userId, String patientId, String patientName, String patientSex, String patientDOB,
String patientPhone, String patientAddress, String diagnosisId, String diagnosisTitle,
String diagnosisDesc, String diagnosisStaus, String diagnosisitime, String medicationId,
String medicationTitle, String medicationPresc, String healthCareId, String

healthCareName, String healthDisp, String healthAccessRight, String vitalSignId, String vitalSignTitle, String vitalSignDesc String vitalHeight, String vitalWidth, , String systolic, String diastolic, String allergiesID, String allergiesTitle, String allergiesDesc, String allergiestime;

String diagnosisdate = new SimpleDateFormat("yyyy-MM-dd").format(new Date());

String medlastbilled = new SimpleDateFormat("yyyy-MM-dd").format(new Date());

String medfrom= new SimpleDateFormat("yyyy-MM-dd").format(new Date());

String medto = new SimpleDateFormat("yyyy-MM-dd").format(new Date());

String allergiesdate = new SimpleDateFormat("yyyy-MM-dd").format(new Date());

Return JSON:

```
[{"UID":"561a27f2","PatientID":"100","PatientName":"Nuha
Sa","PatientSex":"M","PatientDOB":"1992-03-
24","PatientPhone":"9024346162","PatientAddress":"676Gladstone","DiagnosisID":["5,
6"],"Diagnosis":[{"DiagnosisID":"5","DiagnosisTitle":"MyDiagnosisNameHere","Diagn
osisDesc":"MyDescriptionGoesHere","DiagnosisStaus":"Resolved","DiagnosisDate":"20
15-10-
09","DiagnosisTime":"20:20:20"},{"DiagnosisID":"25","DiagnosisTitle":"YourDiagnosi
sNameHere","DiagnosisDesc":"YourDescriptionGoesHere","DiagnosisStaus":"Ongoing"
,"DiagnosisDate":"2016-08-
09","DiagnosisTime":"20:20:20"}],"MedicationID":["5,6"],"Medication":[{"MedicationI
D":"44","MedicationTitle":"MyTitleGoesHere","MedicationPresc":"MyyyyMedicationPr
escGoesHere","MedicationLastBilled":"2015-07-30","MedicationFrom":"2015-05-
09","MedicationTo":"2015-06-
09"},{"MedicationID":"80","MedicationTitle":"YoursadTitleGoesHere","MedicationPre
sc":"YoursMedicationPrescGoesHere","MedicationLastBilled":"2015-09-
22","MedicationFrom":"2015-11-09","MedicationTo":"2015-06-
09"}],"HealthCare":[{"HealthCareID":"11","HealthCareName":"MyHealthNameHere",
"HealthDisp":"MyDispGoesHere","HealthAccessRight":"N"},{"HealthCareID":"10","He
althCareName":"YourHealthNameHere","HealthDisp":"YourDispGoesHere","HealthAc
```

```
cessRight":"Y"}], "VitalSignID": "[5,6]", "VitalSign": [{"VitalSignID": "78", "VitalSignTitle": "MasdTitleGoesHere", "VitalSignDesc": "MyasaskdjDescGoesHere", "VitalHeight": "10", "VitalWidth": "205", "Systolic": "44", "Diastolic": "66"}, {"VitalSignID": "4", "VitalSignTitle": "YouasTitleGoesHere", "VitalSignDesc": "YouasDescGoesHere", "VitalHeight": "40", "VitalWidth": "25", "Systolic": "92", "Diastolic": "414"}], "AllergiesID": "[5,6]", "Allergies": [{"AllergiesID": "55", "AllergiesTitle": "MyAllergiesTitle", "AllergiesDesc": "MyyasAllergyDESC", "AllergiesDate": "2015-07-07", "AllergiesTime": "05:05:05"}, {"AllergiesID": "66", "AllergiesTitle": "YourasAllergiesTitle", "AllergiesDesc": "YoursadadaAllergyDESC", "AllergiesDate": "2015-07-07", "AllergiesTime": "05:05:05"}]}, {"UID": "561a27f3", "PatientID": "100", "PatientName": "Nuha Sa", "PatientSex": "M", "PatientDOB": "1992-03-25", "PatientPhone": "9024346162", "PatientAddress": "676Gladstone", "DiagnosisID": "[7,8]", "Diagnosis": [{"DiagnosisID": "5", "DiagnosisTitle": "DupMyDiagnosisNameHere", "DiagnosisDesc": "DupMyDescriptionGoesHere", "DiagnosisStaus": "Resolved", "DiagnosisDate": "2015-10-09", "DiagnosisTime": "20:20:20"}, {"DiagnosisID": "25", "DiagnosisTitle": "DupYourDiagnosisNameHere", "DiagnosisDesc": "DupYourDescriptionGoesHere", "DiagnosisStaus": "Ongoing", "DiagnosisDate": "2016-08-09", "DiagnosisTime": "20:20:20"}], "MedicationID": "[7,8]", "Medication": [{"MedicationID": "44", "MedicationTitle": "DupMyTitleGoesHere", "MedicationPresc": "DupMyyyyMedicationPrescGoesHere", "MedicationLastBilled": "2015-07-30", "MedicationFrom": "2015-05-09", "MedicationTo": "2015-06-09"}, {"MedicationID": "80", "MedicationTitle": "DupYoursadTitleGoesHere", "MedicationPresc": "DupYourssMedicationPrescGoesHere", "MedicationLastBilled": "2015-09-22", "MedicationFrom": "2015-11-09", "MedicationTo": "2015-06-09"}], "HealthCare": [{"HealthCareID": "11", "HealthCareName": "DupMyHealthNameHere", "HealthDisp": "DupMDyDispGoesHere", "HealthAccessRight": "N"}, {"HealthCareID": "10", "HealthCareName": "DupYourHealthNameHere", "HealthDisp": "DupYourDispGoesHere", "HealthAccessRight": "Y"}], "VitalSignID": "[7,8]", "VitalSign": [{"VitalSignID": "78", "VitalSignTitle": "DupMasdTitleGoesHere", "VitalSignDesc": "DupMyasaskdjDescGoesHere", "VitalHeight": "10", "VitalWidth": "205", "Systolic": "44", "Diastolic": "66"}, {"VitalSignID": "4", "VitalSignTitle": "DupYouasTitleGoesHere", "VitalSignDesc": "DupYouasDescGoesHere", "VitalHeight": "40", "VitalWidth": "25", "Systolic": "92", "Diastolic": "414"}], "AllergiesID": "[7,8]", "Allergies": [{"AllergiesID": "66", "AllergiesTitle": "DupYourasAllergiesTitle", "AllergiesDesc": "DupYoursadadaAllergyDESC", "AllergiesDate": "2015-07-07", "AllergiesTime": "05:05:05"}, {"AllergiesID": "55", "AllergiesTitle": "DupMyAllergiesTitle", "AllergiesDesc": "DupMyyyasAllergyDESC", "AllergiesDate": "2015-07-07", "AllergiesTime": "05:05:05"}]}]}
```

Chapter 5

Case Study and Application Interface

Patients, doctors and pharmacists can register to the application after the administrator's acceptance and after providing the following information: first name, last name, nationality, SIN, gender, DOB, address, phone number, email, user name(for the registration), password, and occupation (as shown in figure 15).

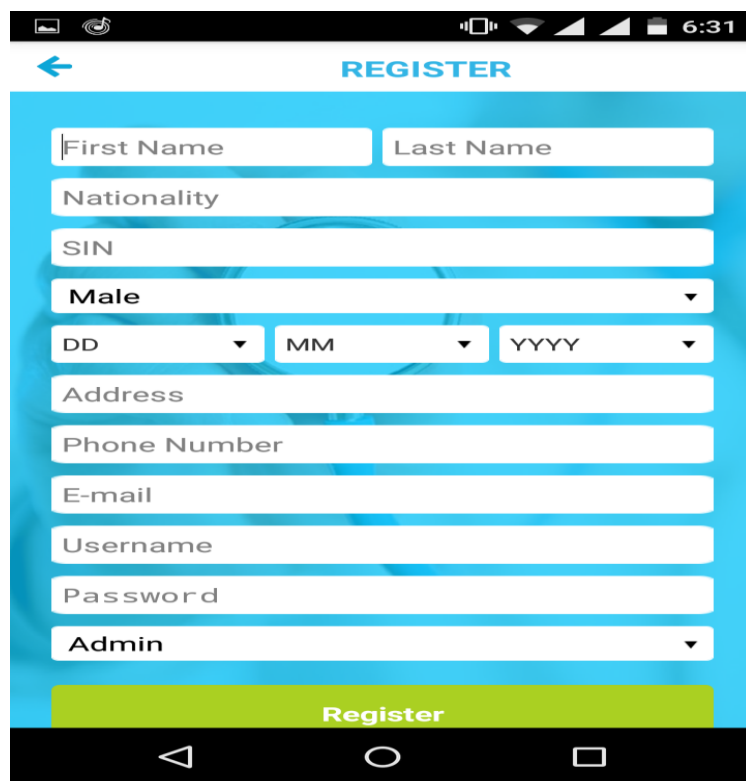

The screenshot shows a mobile application interface for registration. The page is titled "REGISTER" and has a blue background. The form contains the following fields:

- First Name
- Last Name
- Nationality
- SIN
- Gender (set to Male)
- DOB (DD, MM, YYYY)
- Address
- Phone Number
- E-mail
- Username
- Password
- Occupation (set to Admin)

A green "Register" button is located at the bottom of the form.

Figure 20: Registration Page

If the user is a doctor, as demonstrated in figure 16, the doctor should enter the following information: doctor's position, doctor's specialization and hospital's name.

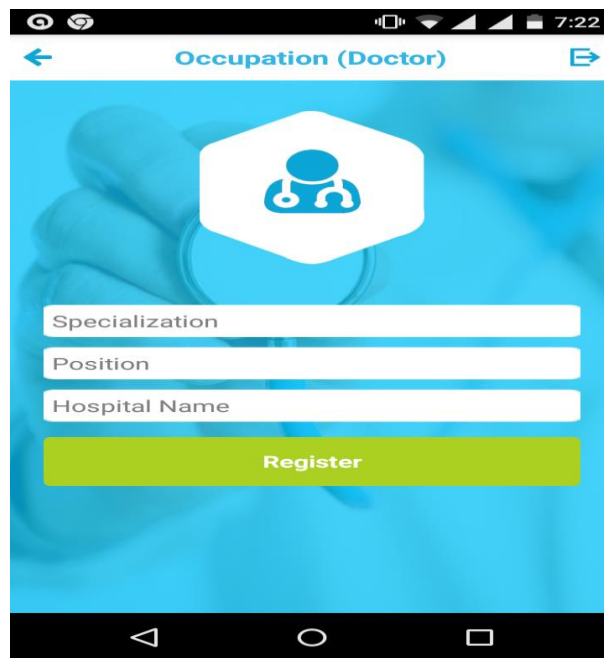

Figure 21: Occupation (Doctor)

If the user is pharmacist, as shown in figure 17, the pharmacist should enter the following details: pharmacy's name and pharmacist's position.

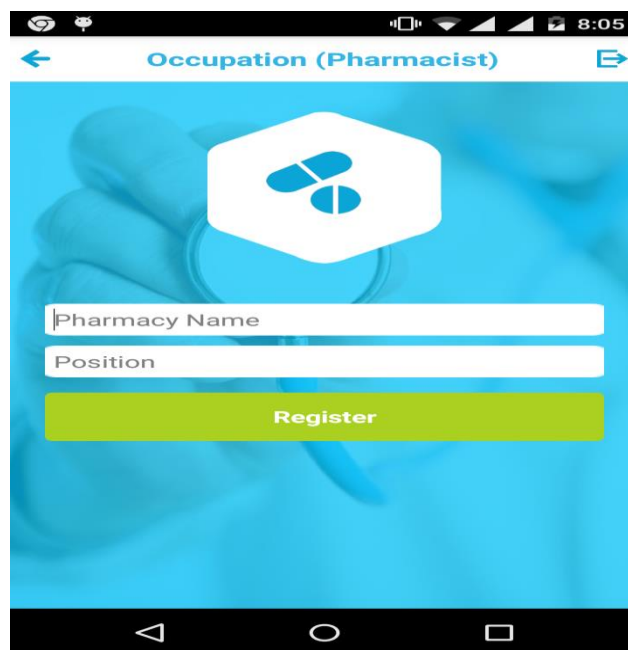

Figure 22: Occupation (Pharmacist)

After registration, the user will receive a confirmation email and will be able login by entering username entered at the registration screen and password (as shown in figures 18 and 19).

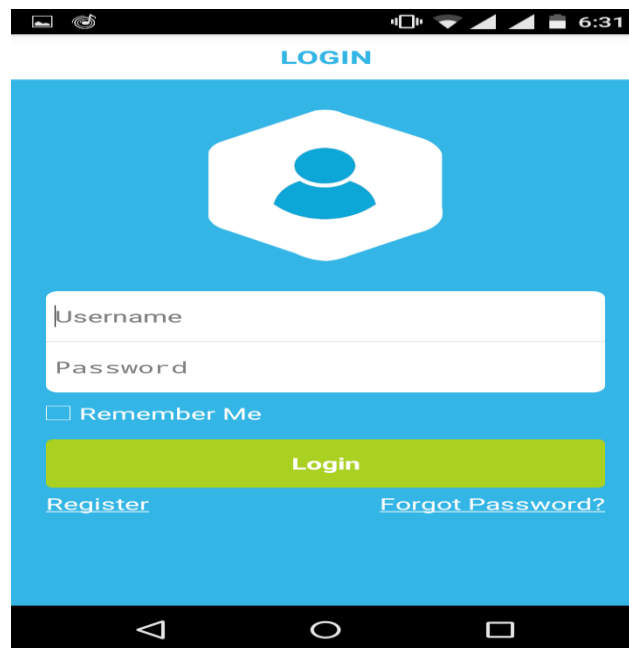

Figure 23: Login Page

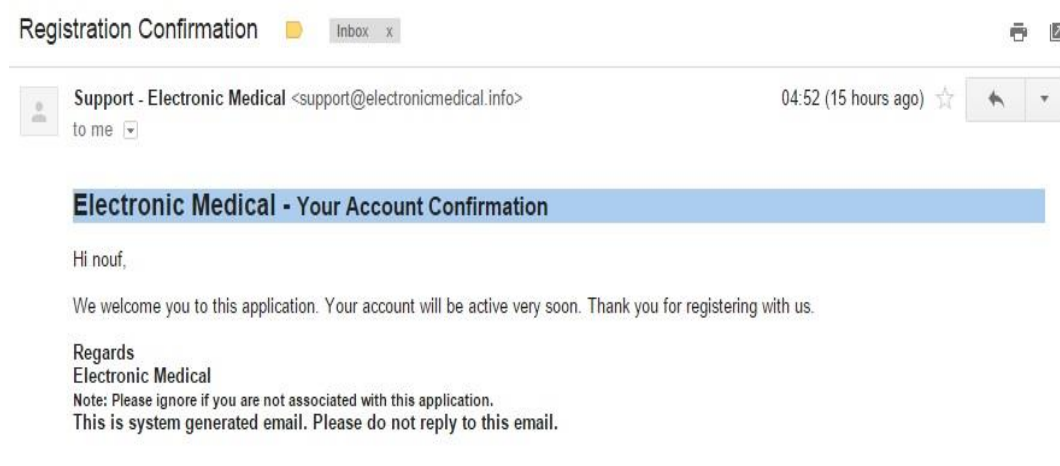

Figure 24: Confirmation email

User can click on Forgot Password, when s/he forget the password. By entering the user's email and SIN the password will be sent through email to the user (as shown in figures 20 and 21).

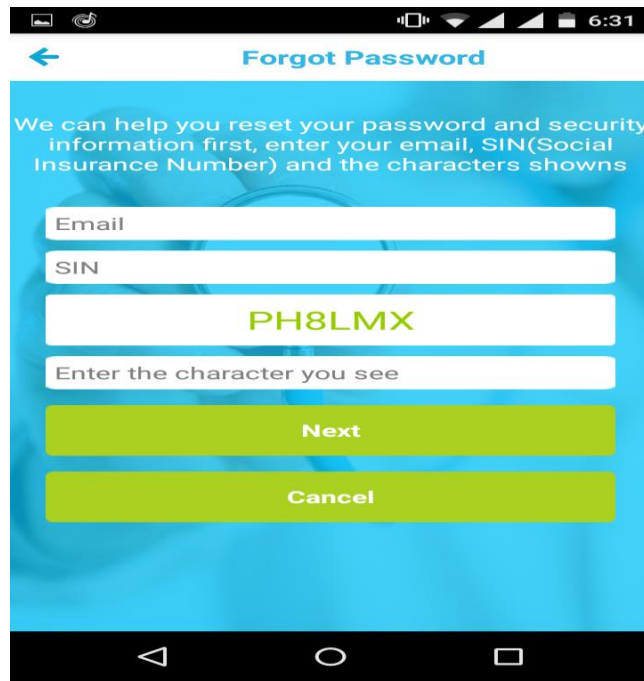

Figure 25: forgot Password Page

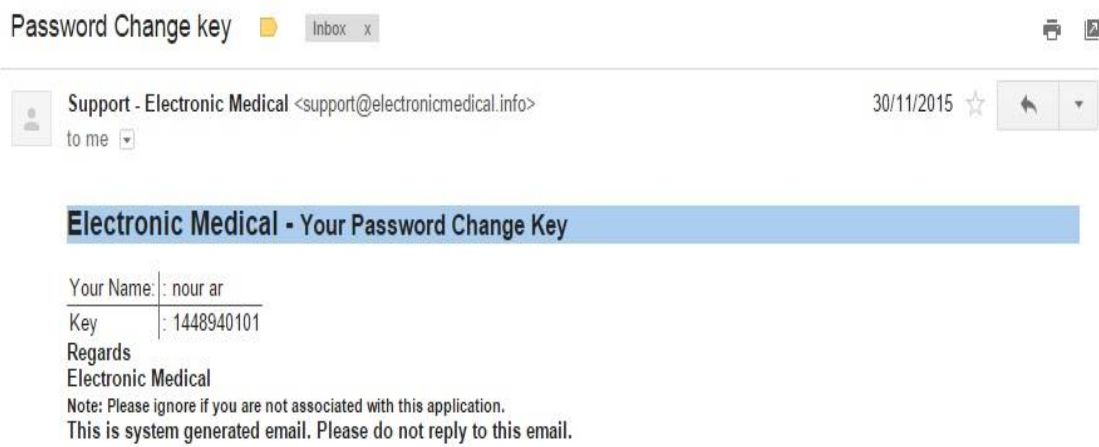

Figure 26: Password Change Key

5.1 Patient Case study

The interface has two options that the patient can choose from: Hospital or Pharmacy (as shown in figure 22). The hospital button leads to an interface that provides two hospitals (IWK or QEII) .The patient has the option to choose the hospital that s/he desires. Each hospital has the patient's medical reports, laboratory reports and radiology reports (as shown in figures 23, 24, 25 and 26).

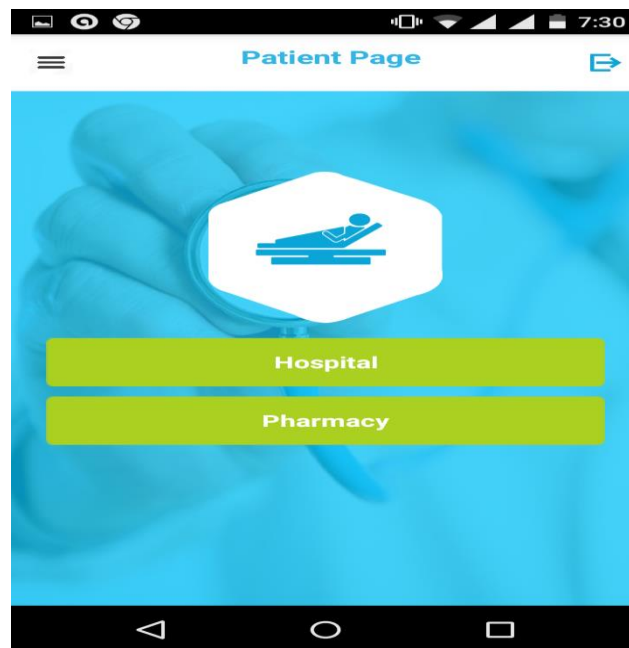

Figure 27: Hospital or Pharmacy Patient Page

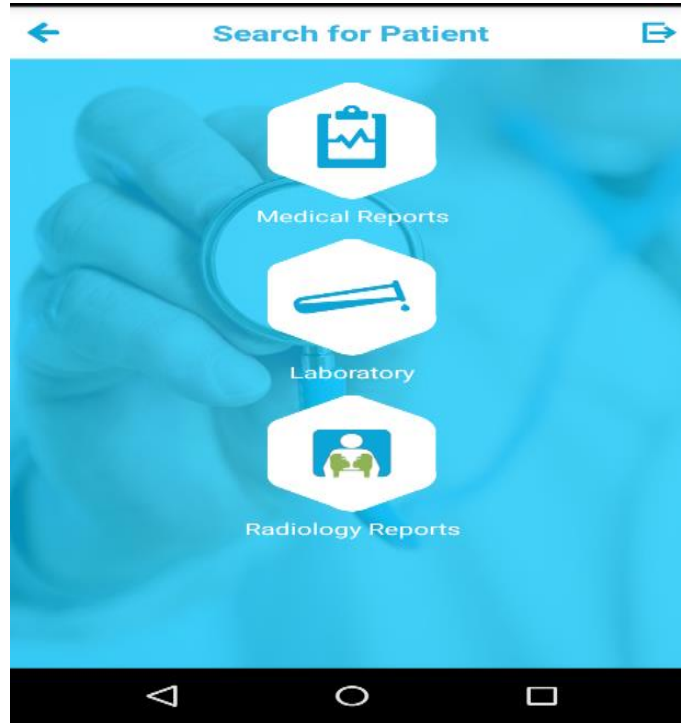

Figure 28: Search for Patient Screen

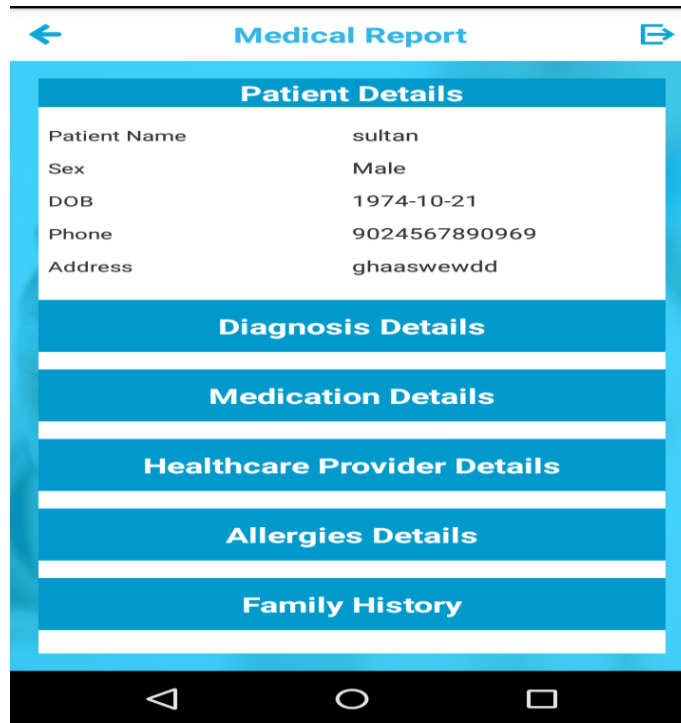

Figure 29: View Medical Report Screen

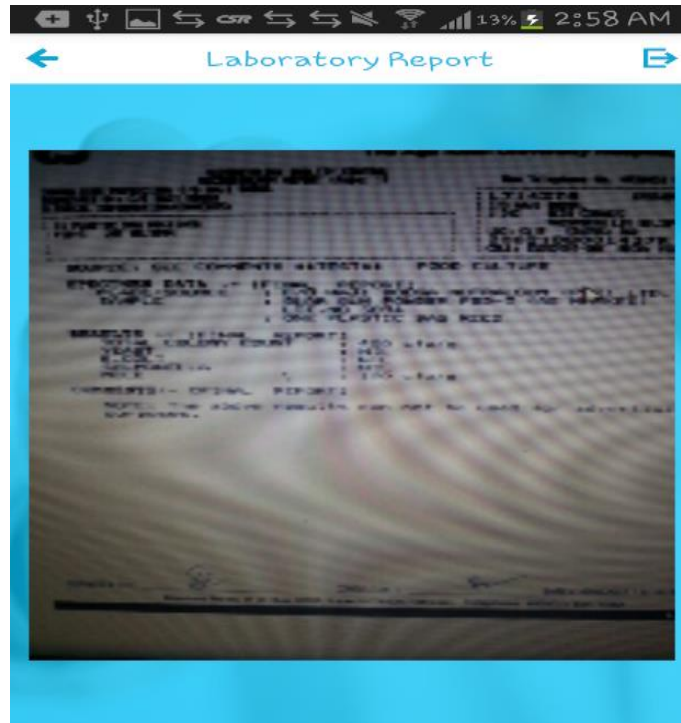

Figure 30: View Laboratory Report Screen

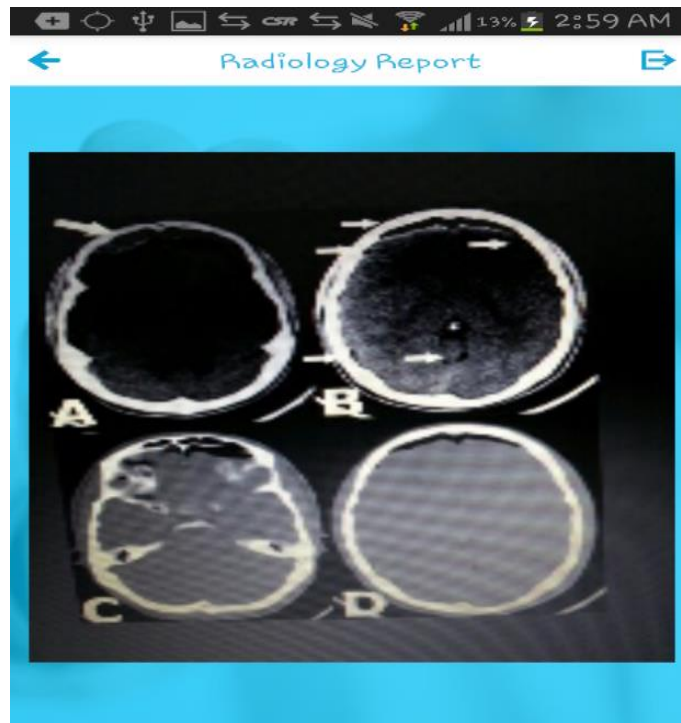

Figure 31: View Radiology Report Screen

As shown in figure 27, the pharmacy button leads to an interface that provides two options: View Prescription or Get My Prescription Ready. The View Prescription button leads to an interface that views the patient's prescription. As shown in figures 28 and 29, the Patient can view his/her prescription by selecting medicine name, date, pharmacy name and pharmacy address. The Get my Prescription Ready button leads to an interface that provides the prescription ready to pick up by giving the following information: prescription number, pharmacy name, pharmacy branch (closest pharmacy), DOB, preferred date and time (As shown in figure 30).



Figure 32: Pharmacy Screen

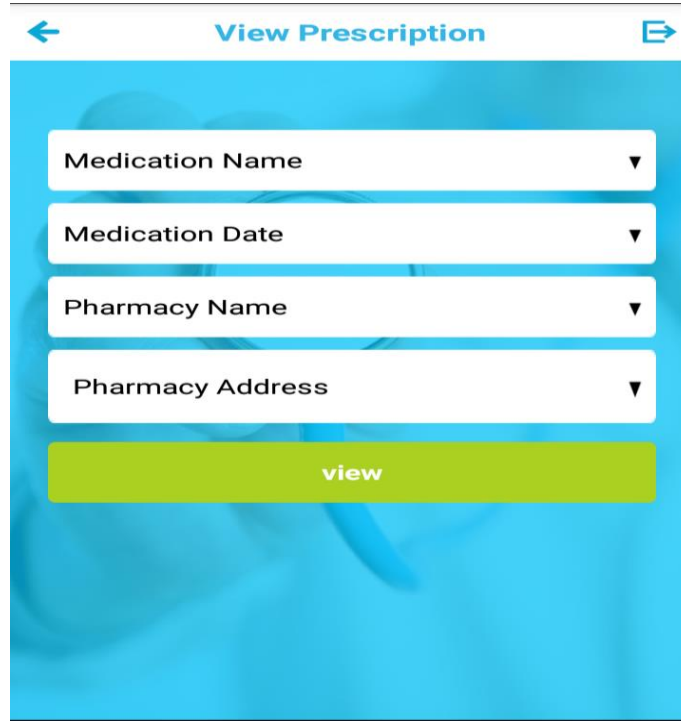

Figure 33: View Prescription Screen

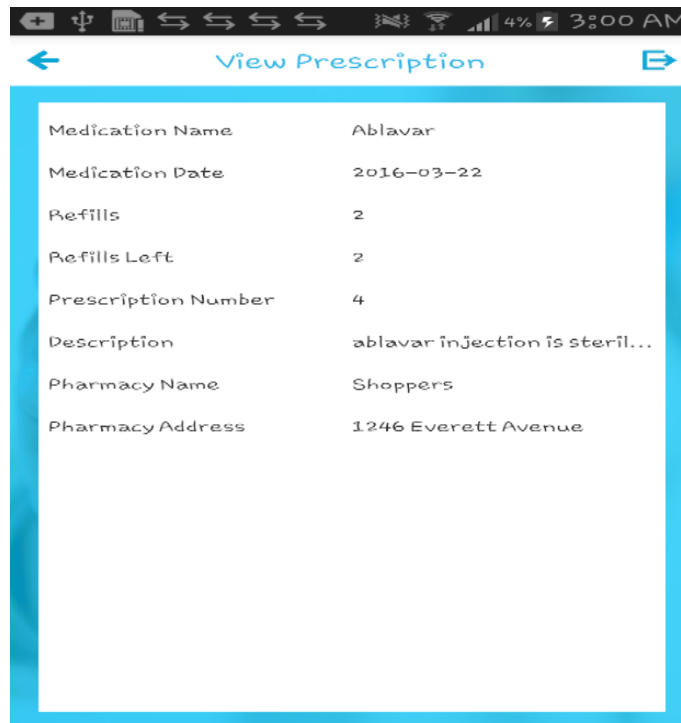

Figure 34: View Prescription Details

Prescription Number

Pharmacy Branch

Whites Pharmacy

Birth of Date

DD MM YYYY

Preferred Date

DD MM YYYY

Preferred time

Submit

Add more prescription

Figure 35: Get my Prescription Ready Screen

5.2 Doctor Case Study

The doctor's specialization, position and the name of the hospital that s/he works in is provided for registration. The Doctor's interface has one option which is Search for Patient. As shown in figure 31, Search for Patient button leads to an interface that asks the doctor to enter the patient's first name, last name and file number. Then, the doctor can view the patient's medical report, laboratory report and radiology report (As shown in figure 32).

As figure 33 demonstrates, Add Prescription button leads to an interface that asks the doctor to enter the medication name, number of refills, and description. Prescription number will be created automatically and will be sent to the patient through email and the pharmacist through the system.

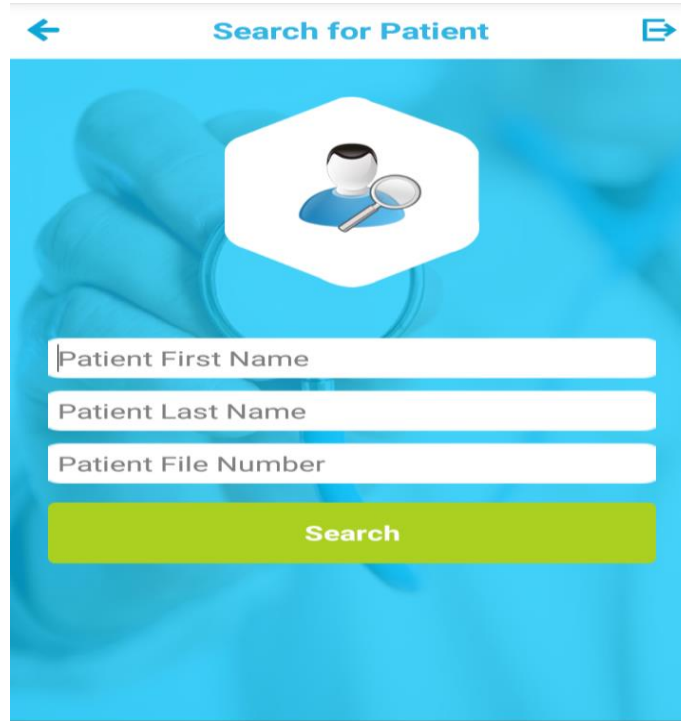

Figure 36: Search for Patients Screen

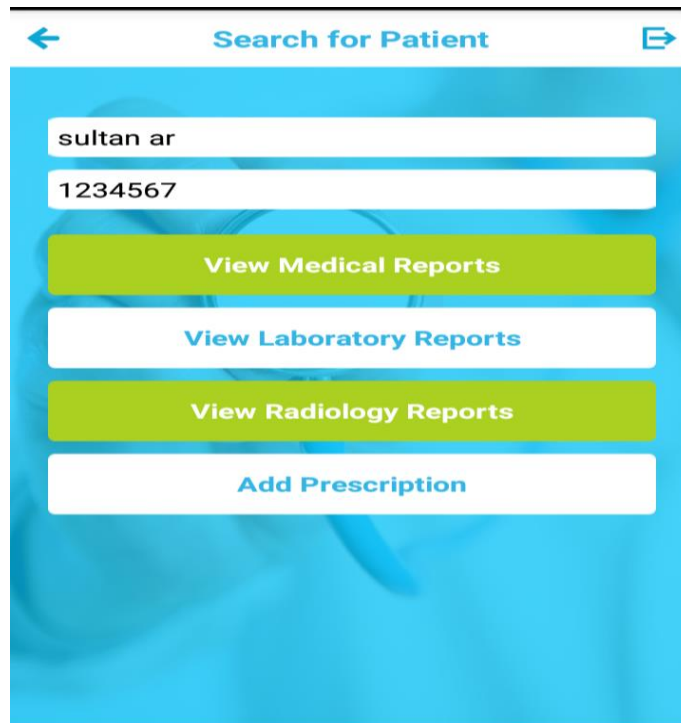
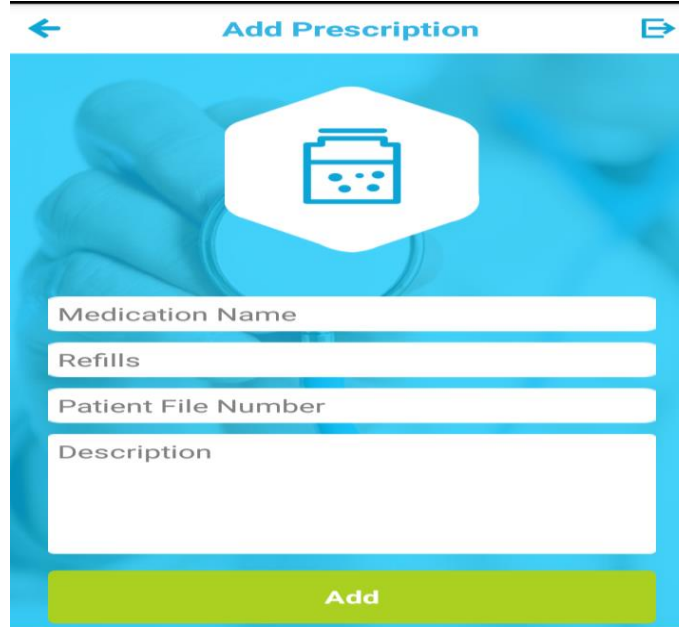

Figure 37: Search for Patient Screen 2



The screenshot shows a mobile application interface for adding a prescription. The title bar is blue with a back arrow on the left, the text "Add Prescription" in the center, and a forward arrow on the right. Below the title bar is a white hexagonal icon containing a blue pharmacy bottle icon. The main content area is white and contains four input fields: "Medication Name", "Refills", "Patient File Number", and "Description". At the bottom of the screen is a green button labeled "Add".

Figure 38: Add Prescription Screen

5.3 Pharmacist Case Study

In order for the pharmacist to register, s/he should provide the system with the pharmacy name s/he is working at, pharmacy's branch and his/her position. The Pharmacist's interface has one option, which is Search for Patient. Search for Patient button leads to an interface that asks the pharmacist to enter the patient's first name, last name and file number .As figure 34 shows, the pharmacist has three options: Send email, View Insurance and Update Insurance. Send email button leads to an interface that allows the pharmacist to send an email to the patient to notify him/her that the prescription is ready to pick up (as shown in figure 35). View Insurance button leads to an interface the shows the insurance information by choosing the insurance type (as figure 36 shows). Finally, Update Insurance

button leads to an interface that allows the pharmacist to edit the insurance details such as, insurance type and name (as figure 37 demonstrates).

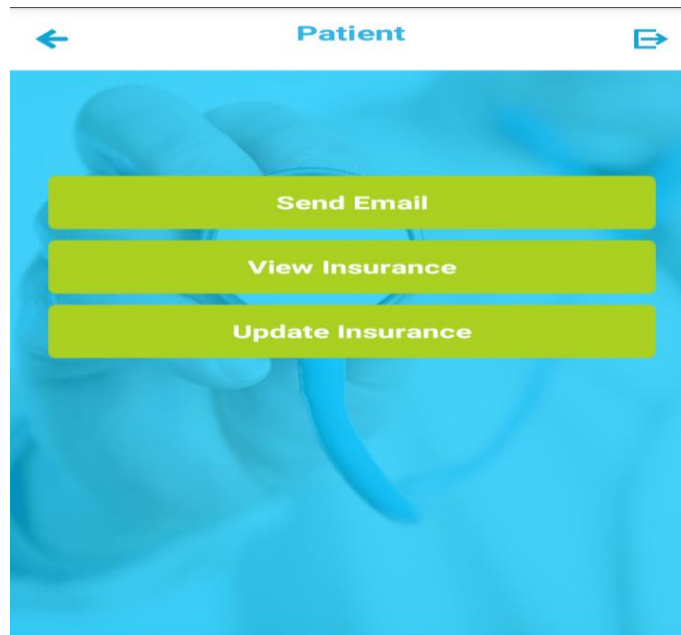

Figure 39: Pharmacist Screen

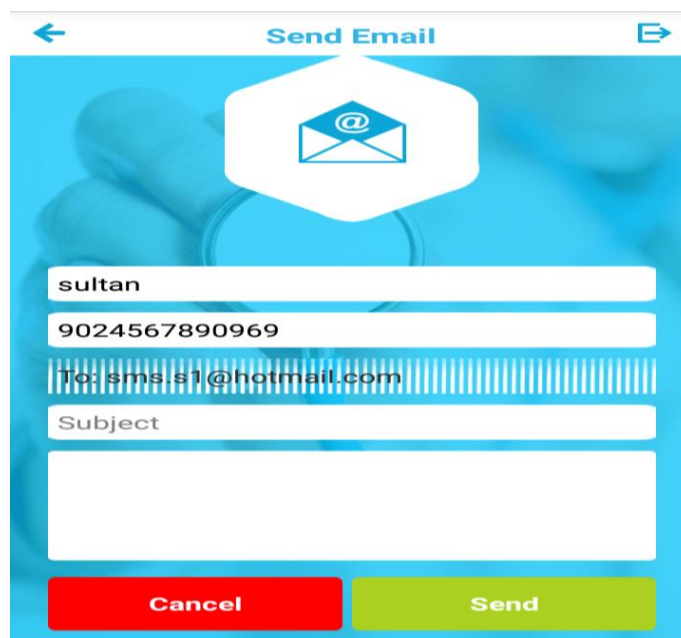

Figure 40: Send email Screen

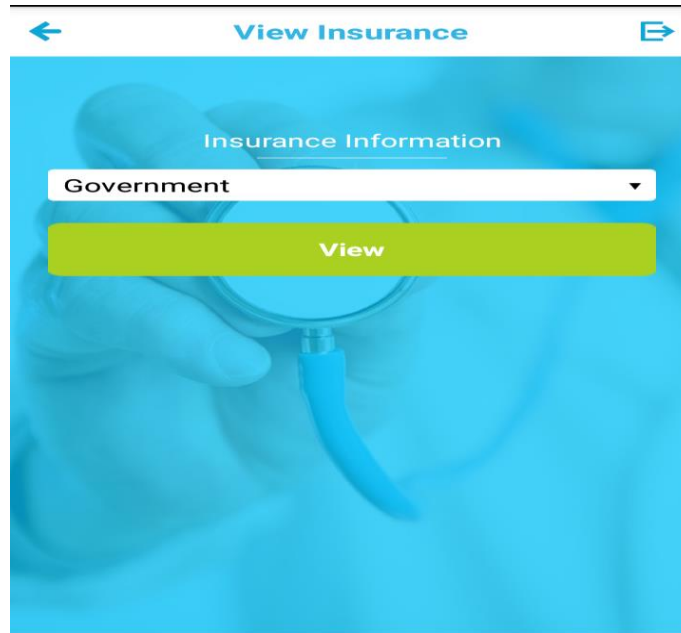

Figure 41: View Insurance Screen

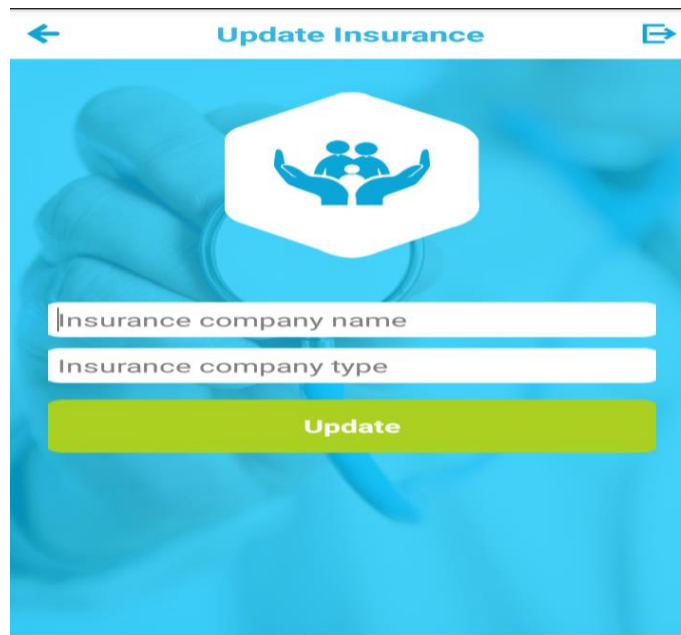

Figure 42: Update Insurance Screen

5.4 Admin Case Study

The administrator's interface has the option to search for a patient. As figure 38 demonstrates, admin can search for a user by entering the following information:

Username, SIN and DOB. If the user is a patient, Search button leads to an interface that gives the admin three options: Edit, Upload Reports and Back (as shown in figure 39). Edit Patient button leads to an interface that allows the admin to edit the patient's information (as figure 40 shows). Upload Reports button leads to an interface that allows the admin to upload the patient's reports (radiology reports, laboratory reports and medical reports) after the doctor's permission (as shown in figures 41 and 42). Back button leads to the previous interface. If the user is a doctor, Search button leads to an interface with two options: Edit and Back. Edit button leads to an interface that allows the admin to edit the doctor's details with the hospital's permission.



The screenshot shows a mobile application interface titled "Search for User". At the top, there is a navigation bar with a back arrow on the left, the title "Search for User" in the center, and a forward arrow on the right. Below the navigation bar is a large white hexagonal icon with a magnifying glass over a person silhouette. Underneath the icon are three input fields: the first contains the text "sultan", the second is empty and labeled "SIN", and the third is a date picker with three dropdown menus labeled "DD", "MM", and "YYYY". At the bottom of the form is a green button with the text "Search".

Figure 43: Search for User (Admin Screen)

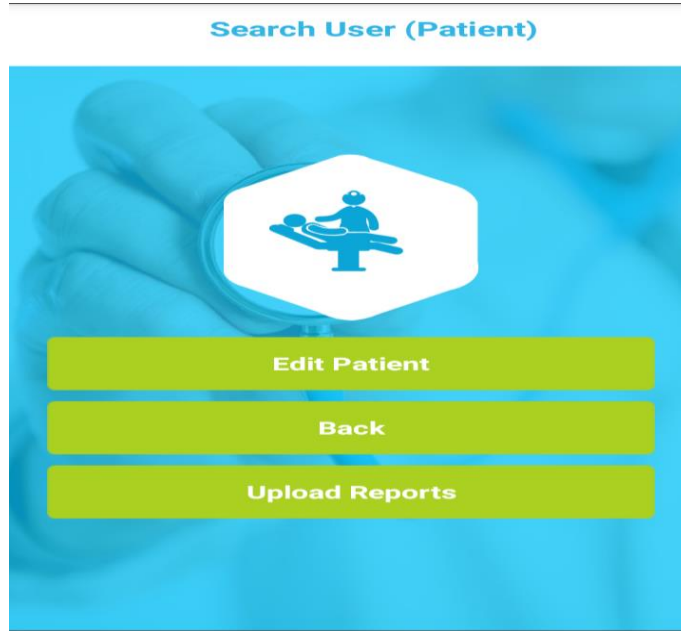

Figure 44: Search Screen (Patient)



Figure 45: Edit Patient Screen

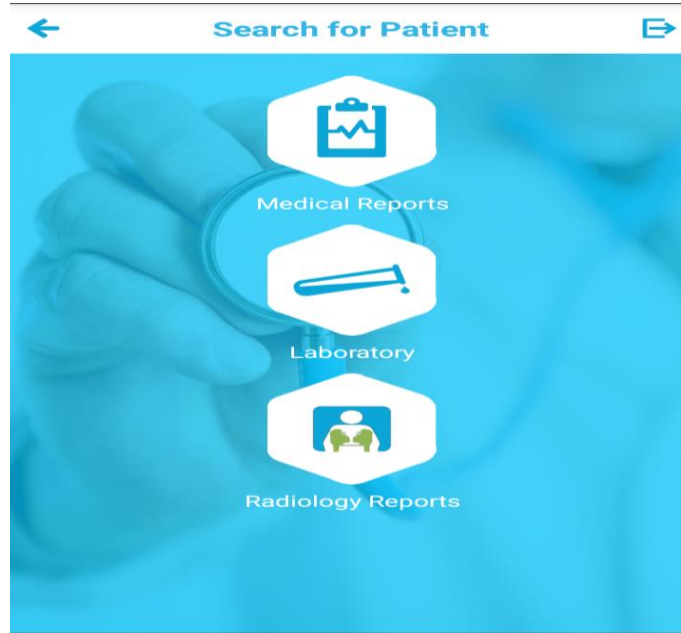

Figure 46: Edit Reports Screen

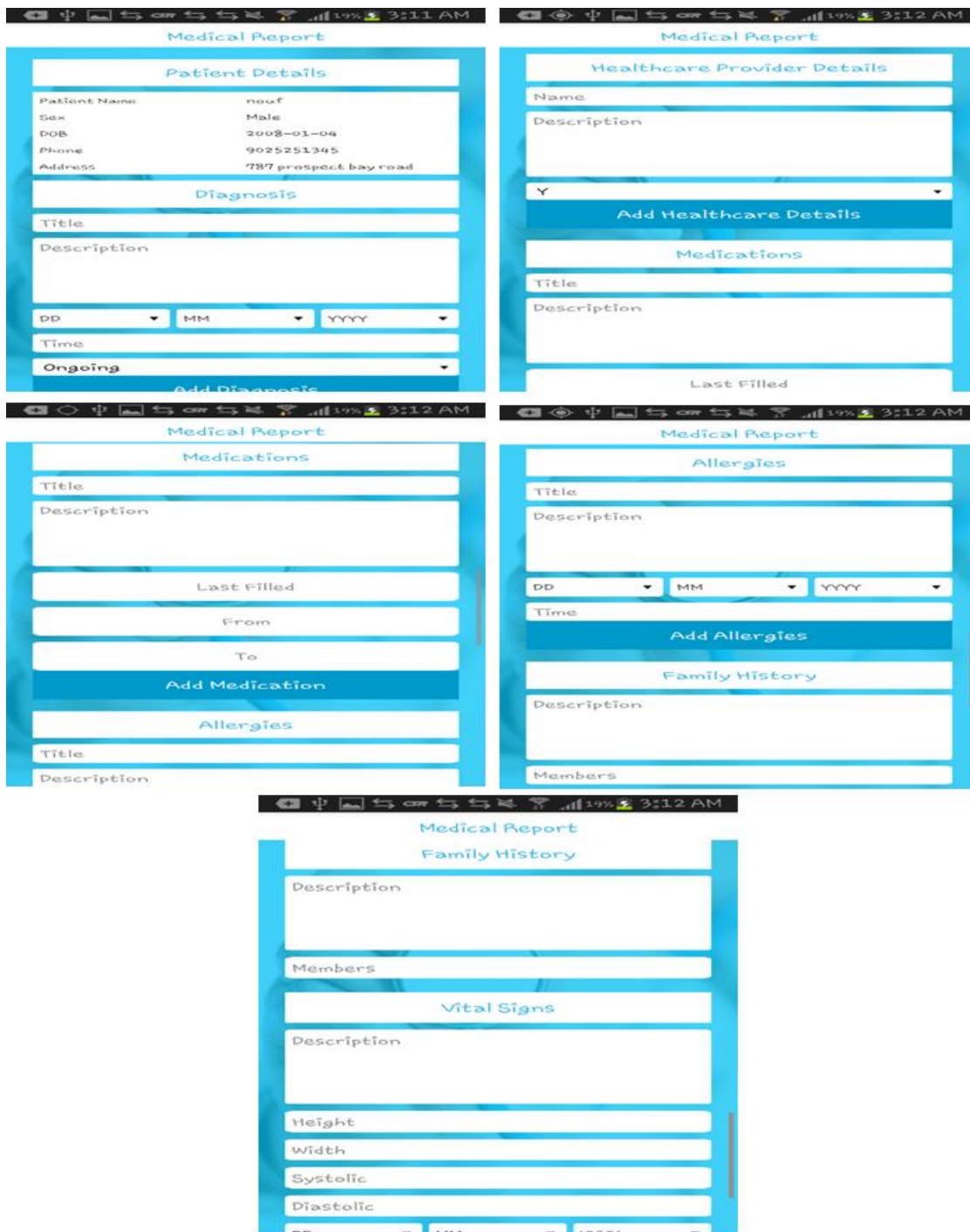

Figure 47: Edit medical report screen

Chapter 6

Conclusions and Future Work

6.1 Conclusions

Mobile technologies and communication technologies have extended to mobile devices. Unusual and unpredictable events are generated in daily hospital routines. Not having the required and accurate information as needed may cause medical errors. In this thesis, we propose a solution for improving healthcare providers and patients' communication through the detailed architecture and design of the next generation mobile healthcare application. The proposed mobile healthcare application has huge potential to improve healthcare quality, improve efficiency, empower patients to manage their health more comfortably out of the hospital, empower patients to manage their drugs information easily out of the pharmacy, reduce the cost of care by decreasing the number of visits to their doctors and enable healthcare providers to monitor their patient's health.

In this thesis, we employed various software development tools for the analysis, design and implementation of the proposed mobile healthcare application. The proposed mobile healthcare application is capable of supporting the next generation electronic medical and pharmaceutical ERP systems. The proposed mobile application can provide services to several parties in the healthcare sector such as patients, doctors and pharmacists. This thesis demonstrates that the proposed application is capable of decreasing the transaction processing time and cost, and improving flexibility to pervasively access the information anywhere, anytime and as needed.

6.2 Future Work

In future work, we will improve the application by adding an online chatting service between doctors, pharmacists and patients to enable patients to communicate with their healthcare providers and ask questions. Moreover, we plan to incorporate additional services such as appointment booking services, waiting time management services, patient feedback collection services, into the mobile healthcare application. These services are not essential, but will significantly improve patient satisfaction and experience with their healthcare providers. Furthermore, as business analytics and business intelligence will be important components of the next generation electronic medical and pharmaceutical ERP systems, we plan to add the features related to business analytics and business intelligence for supporting the next generation electronic medical and pharmaceutical ERP systems. Additionally, since cloud computing is an unlimited resource and can be accessed at the time and place it is needed, we plan to add it to the proposed application. Cloud computing can improve the reliability and capacity of data, provide a pervasive data access and offer data backup and recovery. However, technical and security issues might be faced when cloud computing will be added to the proposed application. Finally, an evaluation method such as surveys or structured interviews will be provided in order to demonstrate the proposed application success and impact.

Bibliography

- Avancha, S., Baxi, A., & Kotz, D. (2012, November). Privacy in mobile technology for personal healthcare. *ACM Computing Surveys*, 45(1), 1-54. doi:10.1145/2379776.2379779
- Boonstra, A., & Govers, M. J. (2009). Understanding ERP system implementation in a hospital by analysing stakeholders. *New Technology, Work and Employment*, 24(2), 177-193.
- Chakravorty, R. (2006, March). Mobicare: A programmable service architecture for mobile medical care. *Proceedings of UbiCare 2006: The first workshop on ubiquitous and pervasive healthcare, Italy*. Retrieved from: <http://citeseerx.ist.psu.edu/viewdoc/download?rep=rep1&type=pdf&doi=10.1.1.103.8978>
- Consumer e-health portal rolls out. (2010, November). Retrieved from: <http://www.cbc.ca/news/technology/consumer-e-health-portal-rolls-out-1.866998>
- Coyle, S. (2012). Conquering the fear of technology. *Advance for Nurses*. Retrieved from <http://nursing.advancweb.com/Features/Articles/Conquering-the-Fear-of-Technology.aspx>.
- Dinh, H. T., Lee, C., Niyato, D., & Wang, P. (2013). A survey of mobile cloud computing: architecture, applications, and approaches. *Wireless communications and mobile computing*, 13(18), 15871611.

Doukas, C., Pliakas, T., & Maglogiannis, I. (2010). Mobile healthcare information management utilizing cloud computing and android OS. *32nd Annual International Conference of the IEEE Engineering in Medicine and Biology Society*. Buenos Aires: Engineering in Medicine and Biology Society, 1037-1040. doi: 10.1109/IEMBS.2010.5628061

Eclipse Documentation. (n.d.). In Eclipse *website*. Retrieved from http://help.eclipse.org/mars/index.jsp?topic=%2Forg.eclipse.platform.doc.isv%2Fguide%2Fint_eclipse.htm

Hoang, D. B., & Chen, L. (2010, December). Mobile cloud for assistive healthcare (MoCAsH). In *Services Computing Conference (APSCC), 2010 IEEE Asia Pacific* (pp. 325-332). IEEE.

Holzinger, A., Schaupp, K., & Eder-Halbedl, W. (2008). *An investigation on acceptance of ubiquitous devices for the elderly in a geriatric hospital environment: using the example of person tracking* (pp. 22-29). Springer Berlin Heidelberg.

Holzinger, A., Searle, G., & Nischelwitzer, A. (2007). On some aspects of improving mobile applications for the elderly. In *Universal Access in Human Computer Interaction. Coping with Diversity* (pp. 923-932). Springer Berlin Heidelberg.

Jen, W.Y. (2009). Mobile healthcare services in school-based health center. *International Journal of Medical Informatics*, 78(6), 425-34. doi: 10.1016/j.ijmedinf.2008.11.002

- Kafeza, E., Chiu, D.K.W., Cheung, S.C., & Kafeza, M. (2004, June). Alerts in mobile healthcare applications: Requirements and pilot study. *IEEE Transactions on Information Technology in Biomedicine*, 8(2), 173-181. doi:10.1109/TITB.2004.828888
- Katz, J.E., & Rice, R.E. (2009). Public views of mobile medical devices and services: A US national survey of consumer sentiments towards RFID healthcare technology. *International Journal of Medical Informatics*, 78(2), 104-114. doi:10.1016/j.ijmedinf.2008.06.001
- Kay, M., Santos, J., & Takane, M. (2011). mHealth: New horizons for health through mobile technologies. *World Health Organization*, 66-71.
- Kohn, L. T., Corrigan, J. M., & Donaldson, M. S. (2002). To err is human: building a safer health system. *National Academy of Science, Institute of Medicine*.
- Kopec, D., Kabir, M. H., Reinharth, D., Rothschild, O., & Castiglione, J. A. (2003). Human errors in medical practice: systematic classification and reduction with automated information systems. *Journal of medical systems*, 27(4), 297-313.
- Kotz, D., Avancha, S., & Baxi, A. (2009, November). A privacy framework for mobile health and homecare systems. In *Proceedings of the Workshop on Security and Privacy in Medical and Home-Care Systems (SPIMACS)*. ACM, 1-12. DOI 10.1145/1655084.1655086

Kyriacou, E., Pavlopoulos, S., Berler, A., Neophytou, M., Bourka, A., Georgoulas, A., Koutsouris, D. (2003). Multi-purpose HealthCare telemedicine systems with mobile communication link support. *Biomedical Engineering Online*, 2(7),1-12. doi:10.1186/1475-925X-2-7

Lee, R. G., Chen, K. C., Hsiao, C. C., & Tseng C. L. (2007, September). A mobile care system with alert mechanism. *IEEE Transactions on Information Technology in Biomedicine*, 11(5), 507-517. doi:10.1109/TITB.2006.888701

Leon, A. (2008). *Enterprise resource planning*. Tata McGraw-Hill Education.

Lindsay, B., & Gitelman, B. (2012). Communication technology and social media: opportunities and implications for healthcare systems. *Online journal of issues in nursing*, 17(3), 1_16.

Melenhorst, AS., Rogers, W.A., Fisk, AD. (2007). When Will Technology in the Home Improve Older Adults' Quality of Life? In: H. W. Wahl, C. Tesch-Romer, A Hoff (Eds.): Emergence of New Person-Environment Dynamics in Old Age: A Multidisciplinary Perspective. Baywood Publishing, Amityville, NY, pp. 253 – 269

My SQL reference manual. (n.d.). In MySQL website. Retrieved from <http://dev.mysql.com/doc/refman/5.7/en/>

Neff, R., & Fry, J. (2009). Periodic prompts and reminders in health promotion and health behavior interventions: systematic review. *Journal of medical Internet research*, 11(2), e16.

NetBeans IDE 7.0.1 Release Information. (n.d.). In NetBeans website. Retrieved from <https://netbeans.org/community/releases/70/>

Nijland, N., van Gemert-Pijnen, J. E., Kelders, S. M., Brandenburg, B. J., & Seydel, E. R. (2011). Factors influencing the use of a Web-based application for supporting the self care of patients with type 2 diabetes: a longitudinal study. *Journal of Medical Internet Research, 13*(3), e71.

Nkosi, M. T., & Mekuria, F. (2010, November). Cloud computing for enhanced mobile health applications. In *Cloud Computing Technology and Science (CloudCom), 2010 IEEE Second International Conference on* (pp. 629-633). IEEE.

Online health records popular with patients. (2011, January). Retrieved from: <http://www.cbc.ca/news/canada/toronto/online-health-records-popular-with-patients 1.1119091>

PHP. (n.d.). In PHP website. Retrieved from <http://php.net/>

Poba-Nzaou, P., Uwizeyemungu, S., Raymond, L., & Paré, G. (2014). Motivations underlying the adoption of ERP systems in healthcare organizations: Insights from online stories. *Information Systems Frontiers, 16*(4), 591-605.

Rashid, M. A., Hossain, L., & Patrick, J. D. (2002). The evolution of ERP systems: A historical perspective.

- Reuters, T. (2015, March). Hospital patients may worry less after seeing their medical records. Retrieved from: <http://www.cbc.ca/beta/news/health/hospital-patients-may-worry-less-after-seeing-their-medical-records-1.2989137>
- Roberts, S. D. (2011, December). Tutorial on the simulation of healthcare systems. In *Proceedings of the Winter Simulation Conference* (pp. 1408-1419). Winter Simulation Conference.
- Rocha, Á. (2013). Evolution of information systems and technologies maturity in healthcare. *Healthcare Information Technology Innovation and Sustainability: Frontiers and Adoption: Frontiers and Adoption*, 238.
- Schobel, J., Schickler, M., Pryss, R., Nienhaus, H., & Reichert, M. (2013). Using vital sensors in mobile healthcare business applications: Challenges, examples, lessons learned. In *International Conference on Web Information Systems and Technologies* (pp. 509-518).
- Varshney, U. (2007). Pervasive healthcare and wireless health monitoring. *Mobile Networks and Applications*, 12(2-3), 113-127.
- West, D. (2012). How mobile devices are transforming healthcare. *Issues in technology innovation*, 18(1), 1-11.
- Wu, I. L., Li, J. Y., & Fu, C. Y. (2011). The adoption of mobile healthcare by hospital's professionals: An integrative perspective. *Decision Support Systems*, 51(3), 587-596. doi:10.1016/j.dss.2011.03.003

Wu, J. H., Wang, S. C., & Lin, L. M. (2007). Mobile computing acceptance factors in the healthcare industry: A structural equation model. *International Journal of Medical Informatics International Journal of Medical Informatics*, 76(1), 66-77.

Zafar, A. & Hurko, M. (2012, October). Patients gain when doctors' notes are online Retrieved from <http://www.cbc.ca/news/health/patients-gain-when-doctors-notes-are-online-1.1136667>

Ziefle, M., & Röcker, C. (2010). Acceptance of pervasive healthcare systems: A comparison of different implementation concepts. *PervasiveHealth*, 10, 1-6.